

CENTATEQ N-510

For dynamic and fast nesting processing.

CNC processing centre with 3-, 4- or 5-axis solutions.





More information at [homag.com](https://www.homag.com)
CENTATEQ N-510



CENTATEQ N-510 – Everything for the craft.

Our CNC processing centers today already offer technology of the future. And with good reason: Tradition. »Made in Germany« is our motivation and our commitment. Customers the world over associate this quality seal with the very highest standards. And we meet those expectations.

The typical application areas of nesting:

- Creating components for carcass furniture
- Dividing and refining of furniture fronts
- Various possibilities for the automation of the material handling

Setting accents:

- Maximum flexibility for interior designers, joineries and cabinetmakers
- Creating components for the caravan sector and structural-facings sector
- Processing of frame furniture

CONTENTS

04	The Highlights
06	Automation possibilities
12	Optimal material utilization
14	MATRIX table
18	Alternating operation
19	Quality and innovation
20	Main spindle technology
22	Units
24	Drilling technology
26	Tool changer systems
28	powerTouch2
30	Software
34	Apps and digital assistants
36	Safety concepts
38	Robot integration
40	Life Cycle Services
42	Technical data

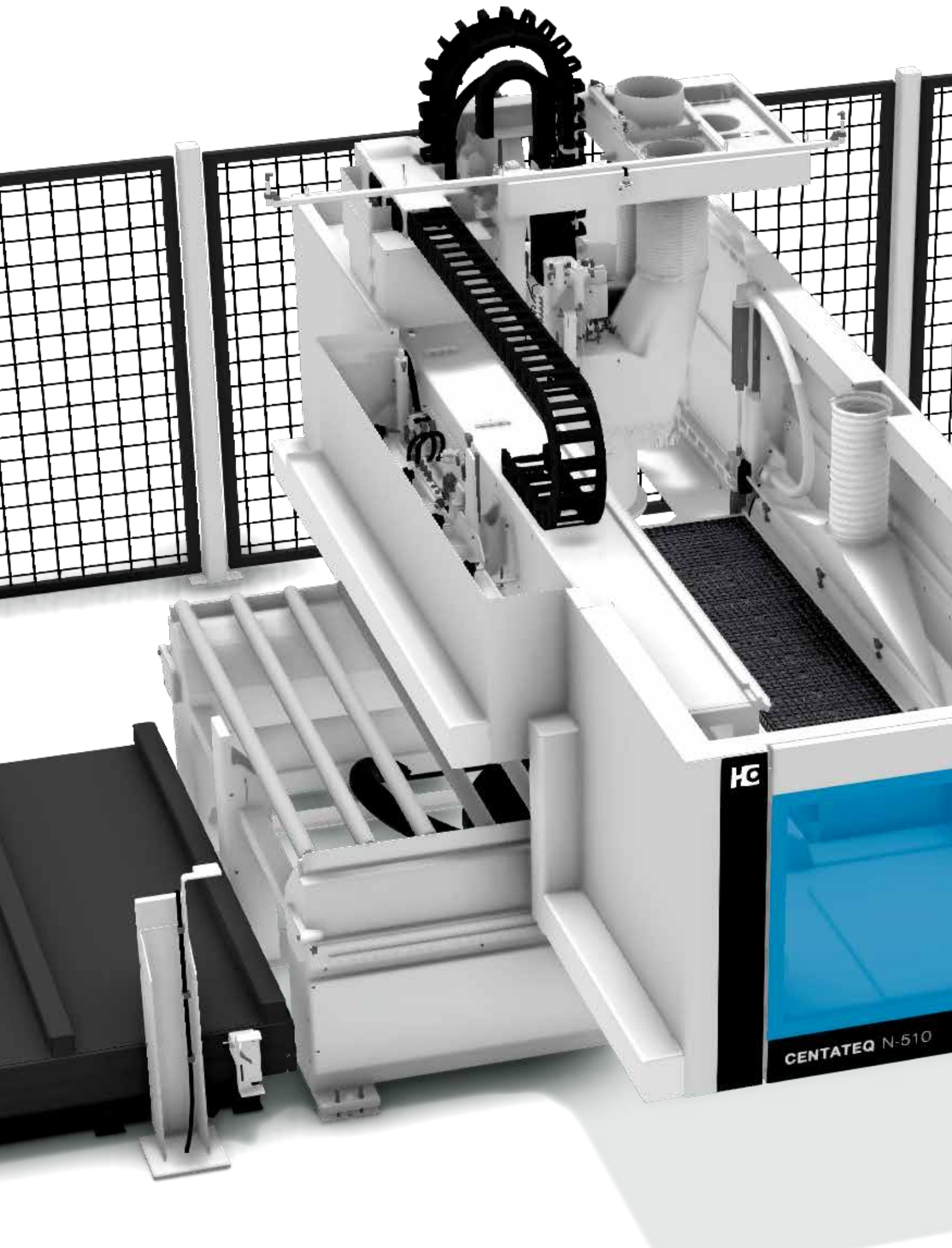

CENTATEQ N-510

The highlights at a glance

FREELY SELECTABLE VACUUM FIELD SEGMENTATIONS OF THE TABLE.

According to requirements or table size with up to 84 vacuum fields.

TOOL CHANGER WITH 8, 14 OR 22 TOOL POSITIONS.

For time-saving handling.

18 DIFFERENT DRILLING GEARS

Different combinations of vertical and horizontal spindles and grooving saws are possible.

14 AUTOMATION POSSIBILITIES

Simple component expansions via plug & play.

NEW DESIGNED MATRIX TABLE

Cross-segment positioning of suction cups without restriction.

3-, 4-, OR 5-AXIS PROCESSING

Offers that little bit extra in processing variety.

70% HIGHER SPEED AND 46% HIGHER DYNAMICS*

For the highest performance and best efficiency ever seen in a fully accessible nesting machine (*compared to previous model).

PATENTED SUCTION CONCEPT

Multi-position extraction for easy integration into production and reduced costs for peripherals.

We have the solution for your nesting requirements!

With the HOMAG nesting solutions you are always well-advised. Whether the workpieces should be fed by hand, by roller conveyor, by lifting carriage or by storage – we have always the proper concept for your application. With our plug & play features, we enable the successive expansion of the machine from the start.

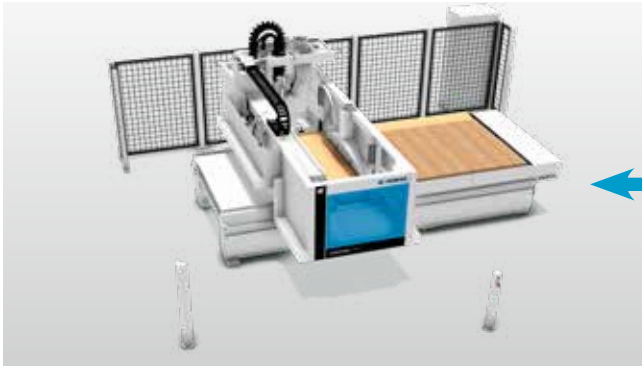

Basic+ including infeed and push-off device

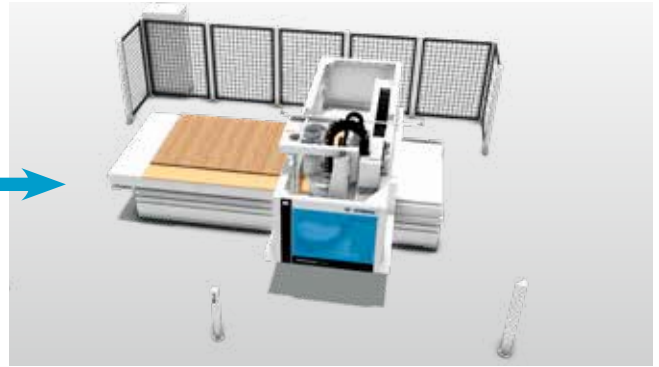

Variants are also available with the flow direction right to left

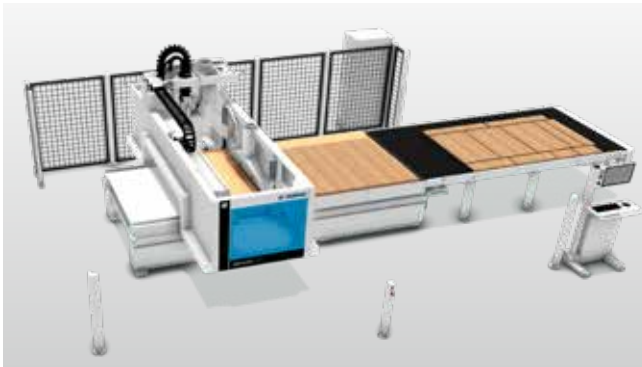

Outfeed+ Automatic push-off for higher productivity

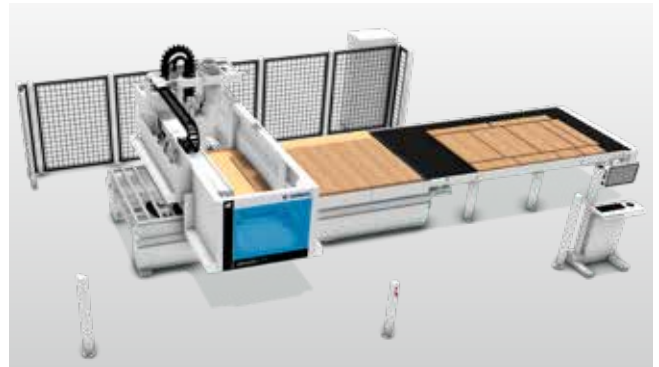

Concept 1+ Prepared for the next expansion stages

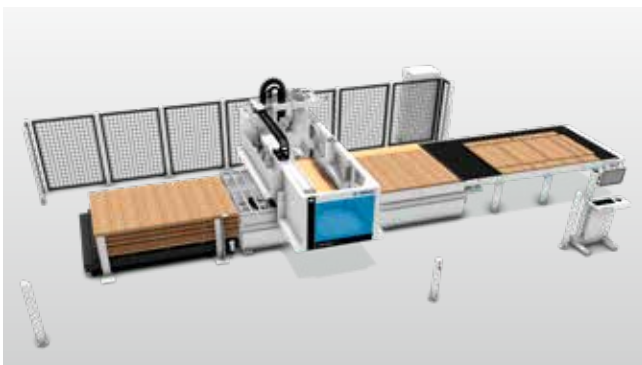

Concept 2H+ Panel handling with lifting table

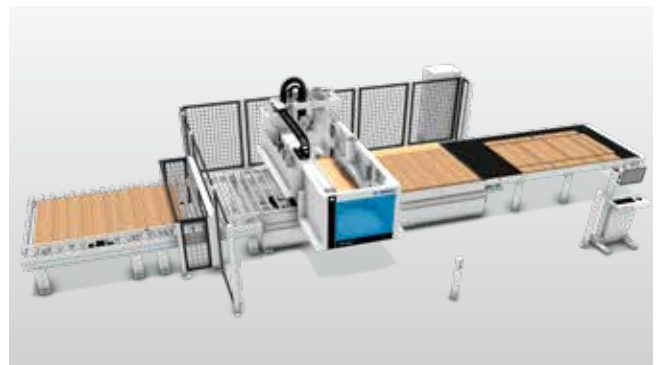

Concept 2R+ Infeed roller conveyor as interface for preceding automation systems

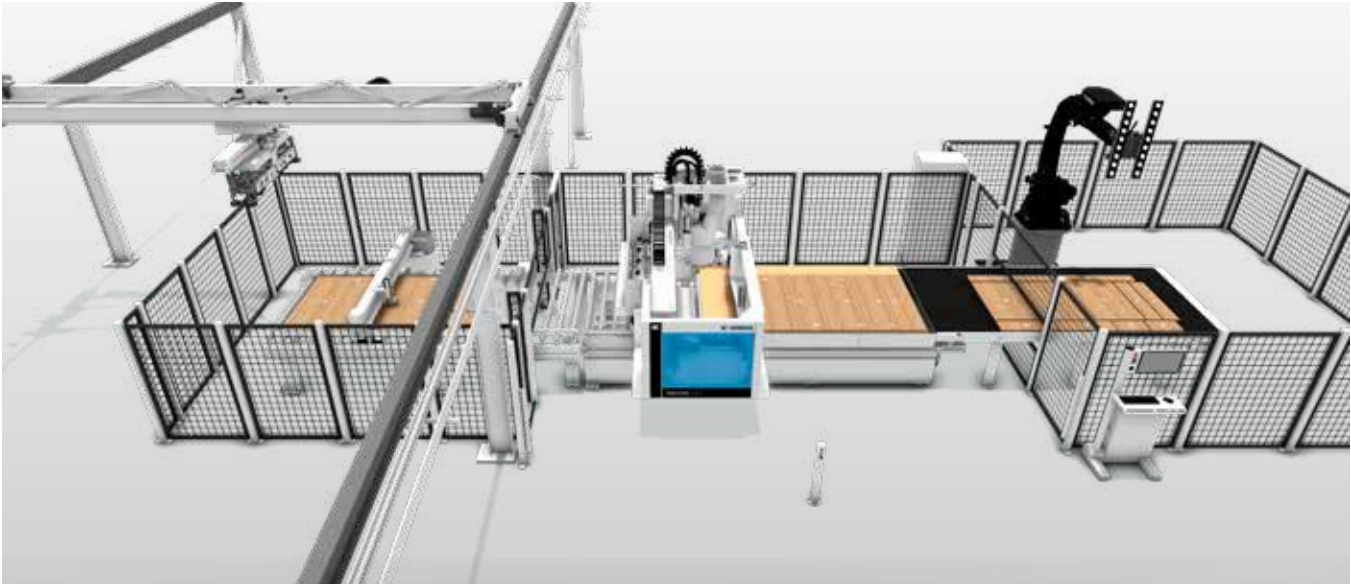
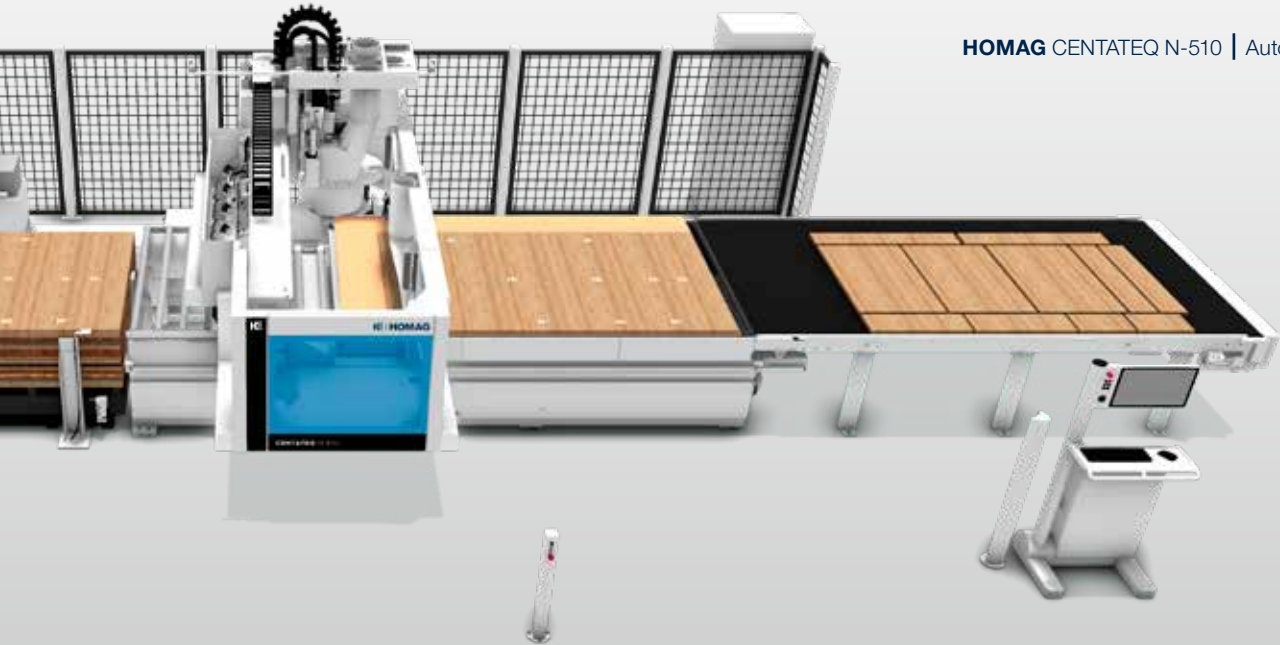

Including destacking via robot



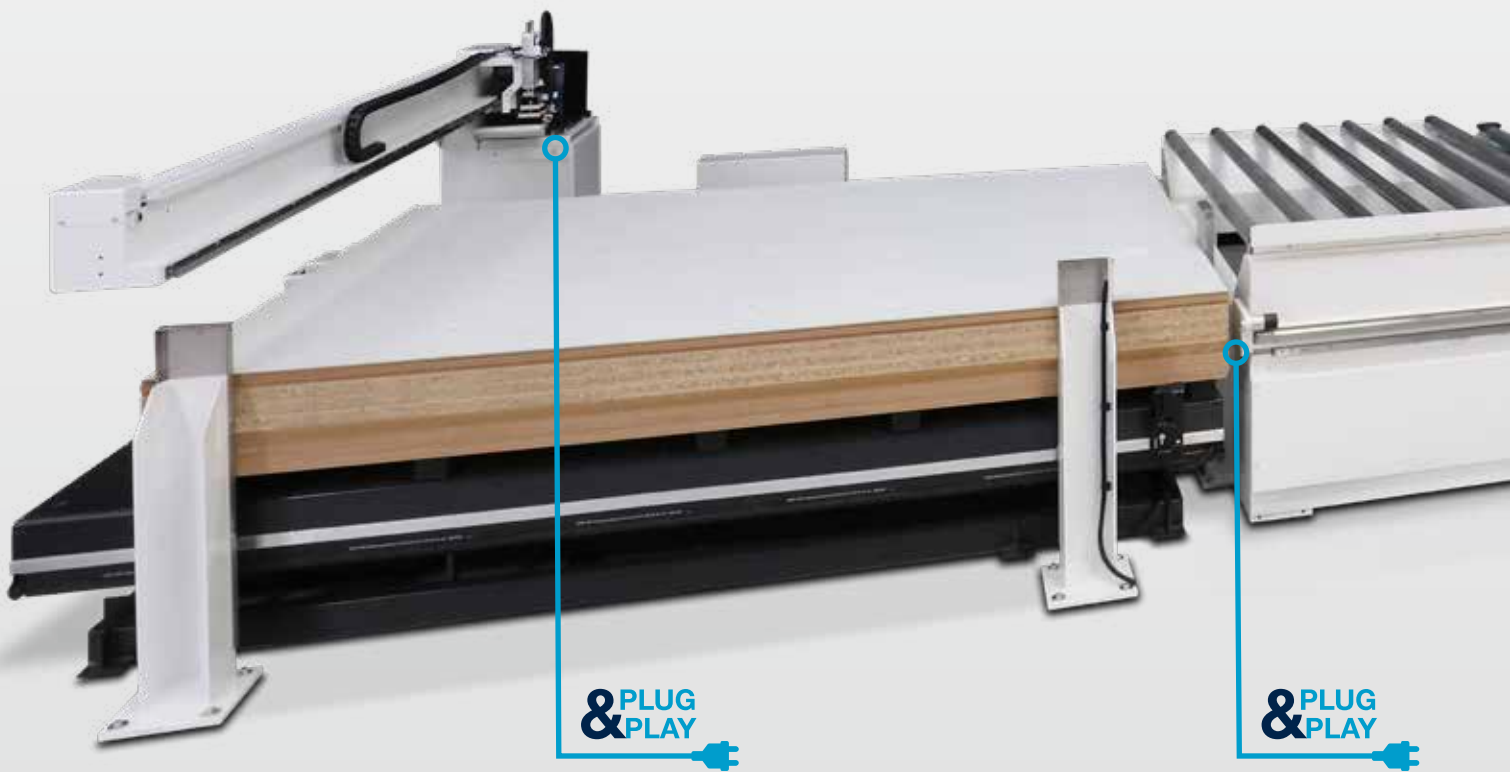

EXEMPLARY AUTOMATION CONCEPT:

- Mechanical and electrical plug & play interface to the machine
- One central control system – operation via HOMAG powerTouch
- Lifting table for automatic and ergonomic loading with automatic labeling at the infeed
- Belt conveyor for automatic pushing off of workpieces in different lengths and at variable speed, supplemented by manual labeling with swivel arm
- Synchronization of work processes through simultaneous infeed, cleaning of the protection panel and push-off
- Cable drag integrated in machine bed for better machine accessibility and protection against dirt



**& PLUG
& PLAY**



Integrated feeding device

- Cleaned-up machine design for protection against dust and dirt. The cleaning effort is reduced.
- Facilitated material handling with an upstream system and automatic positioning of the raw panel for more efficiency and accuracy.



1 Position for the routing spindle

2 Position for the drilling gear

3 Position for the push-off device with integrated suction unit

Central suction connection on the gantry

- For suction on the drilling unit, on the routing spindle and on the suction and push-off device
- Multi-position extraction for easy integration into production and reduced costs for peripherals



Suction hood adjustable

- Individual adjustment to the workpiece thickness
- No flow loss
- Optimal results
- Reduced energy consumption

Blow-off nozzles in the suction hood

- 4 nozzles controllable via program
- Generation of an air flow to guide the chips
- Improvement of the extraction performance

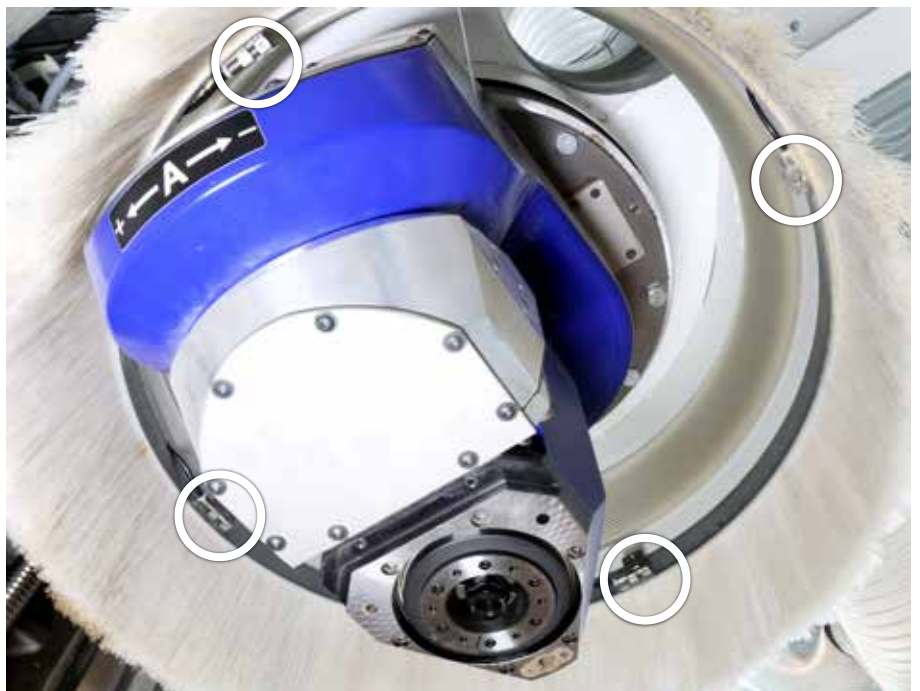



Combined suction and push-off device

- Flow-optimized device for cleaning the protection panel and the workpiece
- Height adjustment manual or automatic
- Processing of 6 mm thick panels as standard (thinner panels on request)

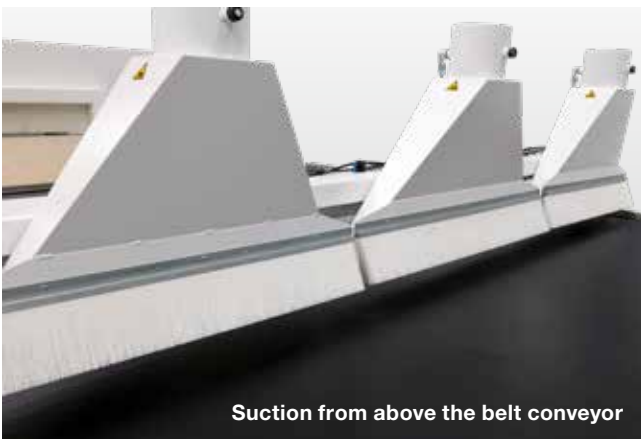

Suction from above the belt conveyor



Suction at the end of the belt conveyor



Suction from below at the machine outfeed

- During outfeed, the workpieces and the spaces between them are cleaned from below
- Height adjustment manual or automatic

Optimal material utilization

Labeling

Detailed part identification through error-free labeling process with information for subsequent processing steps. Control of edge banding machines and CNC processing via barcode possible.

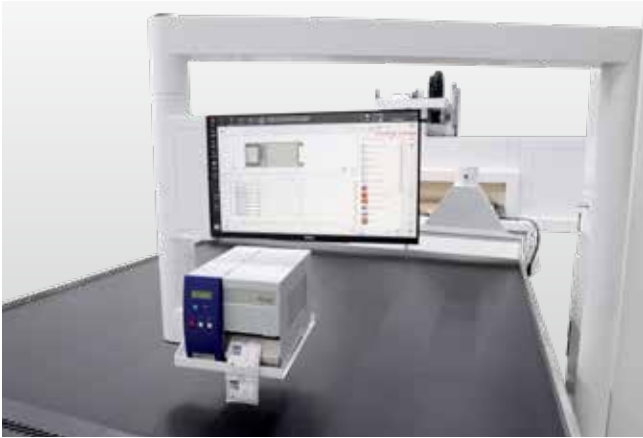

Manual labeling with swiveling arm

- Monitor mounted directly above the belt
- No walking distance to the label printer
- Direct view of the nest



Automatic labeling at the infeed

- Flowing process sequences through automatic labeling during the CNC processing
- Mechanical and electrical plug & play interface to the machine



Nesting Production Set

- App „intelliDivide Nesting“ for cutting optimization
- App „productionAssist Nesting“ for nesting plan selection and initiating label printing.
- Plug & Play label printer
- App „materialManager“ and „materialAssist Boards“ for the management of the raw panels and for the reuse of the remnants



Barcode connection

- Barcodescanner / -software
- Supported barcodes:
1D – Barode,
2D – Data Matrix Code
- Every workpiece is exactly identified for the further workpiece flow

Residual parts management

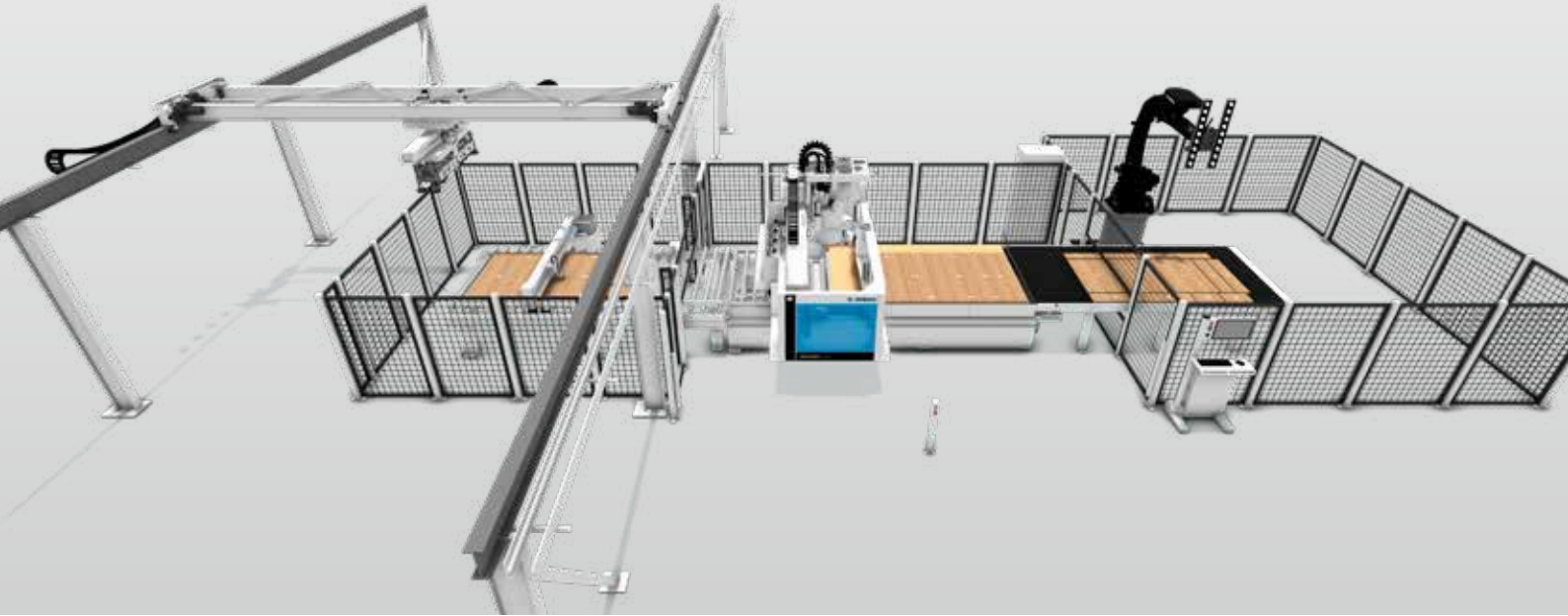

Residual parts management | Basic

- Labels for residual parts from Cut Rite
- Manual management

Residual parts management | Advanced

- Automatic management within the storage database
- Manual positioning in automatic mode
- Labels for residual parts can be produced on the machine itself

Residual parts management | Premium

- Automatic residual parts handling for nesting concepts in conjunction with storage solutions from HOMAG Automation



App »materialAssist Boards«

- The app can be used to manage the stocks and storage locations of the panels and remnants
- Optionally, the panel and remnant rack can be equipped with LED strips: The operator gets support during storage and retrieval by displaying the compartment in question by means of LEDs
- The app is available in the Google Play store and Apple AppStore

The MATRIX table

Table structure & efficient table field occupation

The MATRIX table provides a defined grid of channels and supply points to ensure optimum vacuum distribution for processing with vacuum clamping. By automatically selecting and deselecting the table field occupation, the vacuum is activated in the required area and is effective where it is needed. The areas are optimally matched to the established range of boards. This is specifically designed for the desired flexibility in the use.



Valves

- Valves allow control of each individual vacuum field

New: transition matrix plates

- Continuous grid groove across the entire MATRIX table
- Easy positioning of suction cups across segments
- 30 x 30 mm grid for optimum vacuum flow

Mounting of protective panel

- Fixing points for protective plate integrated in the table

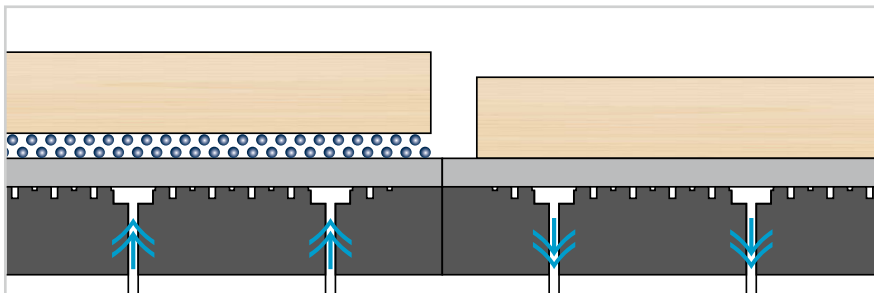

New creation: Functional extension of the air cushion table function

- Generation of an air cushion for workpiece-friendly and ergonomic handling
- Space occupation and air cushion function are optimally matched to each other

Segmentation table

Table dimension in ft (B x L)	Table dimension in mm (L x B)	Number of vacuum fields		
		Classic	Advanced	Premium
4 x 8	2,550 x 1,260	4	n.A.	16
5 x 10	3,180 x 1,590	10	15	25
5 x 12	3,810 x 1,590	12	18	30
5 x 18	5,700 x 1,590	18	27	45
5 x 24	7,590 x 1,590	24	36	60
6 x 12	3,810 x 1,890	12	18	36
7 x 10	3,180 x 2,160	10	15	35
7 x 14	4,440 x 2,160	14	21	49
7 x 18	5,700 x 2,160	18	27	63
7 x 24	7,590 x 2,160	24	36	84

Classic

V2	V4	V6	V8	V10
V1	V3	V5	V7	V9

Example

- Table size: 7 x 10 ft (3,180 x 2,160 mm)
- Segmentation into 10 fields

Highlights

- Classic nesting processing
- Vacuum fields are designed so that common panel dimensions can be selected and deselected

Advanced

V3	V6	V9	V12	V15
V2	V5	V8	V11	V14
V1	V4	V7	V10	V13

Example

- Table size: 7 x 10 ft (3,180 x 2,160 mm)
- Segmentation into 15 fields

Highlights

- Classic nesting processing and small parts
- Vacuum panels are designed so that the common panel dimensions can be selected and deselected independently of the operating side

Premium

V7	V14	V21	V28	V35
V6	V13	V20	V27	V34
V5	V12	V19	V26	V33
V4	V11	V18	V25	V32
V3	V10	V17	V24	V31
V2	V9	V16	V23	V30
V1	V8	V15	V22	V29

Example

- Table size: 7 x 10 ft (3,180 x 2,160 mm)
- Segmentation into 35 fields

Highlights

- Ideal for all types of applications
- Individually controllable vacuum fields on the entire work table
- Table segmentation with up to 84 fields possible

Stop and alignment systems

The correct clamping of the panels and workpieces is the basis for an optimal processing result.

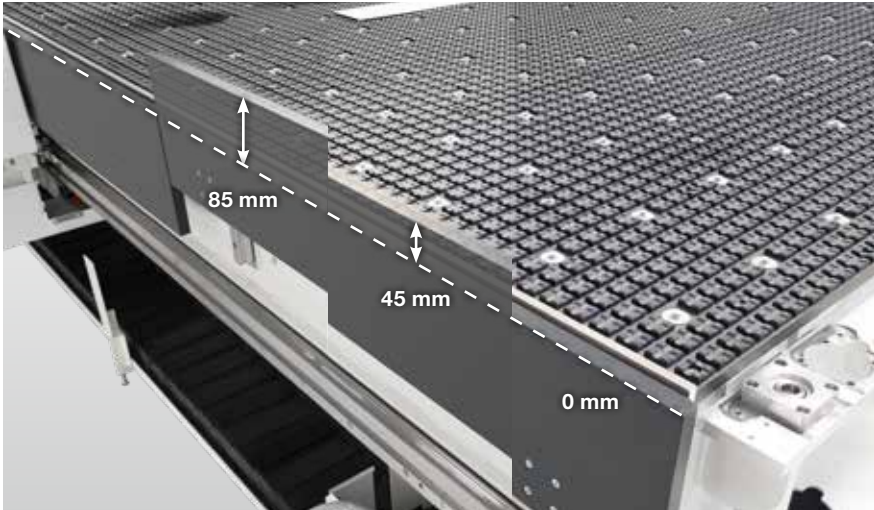

Linear guides

- Application-specific and demand-oriented control of the automated guide rails enables ergonomic handling
- The standardized guide rails allow for precise positioning

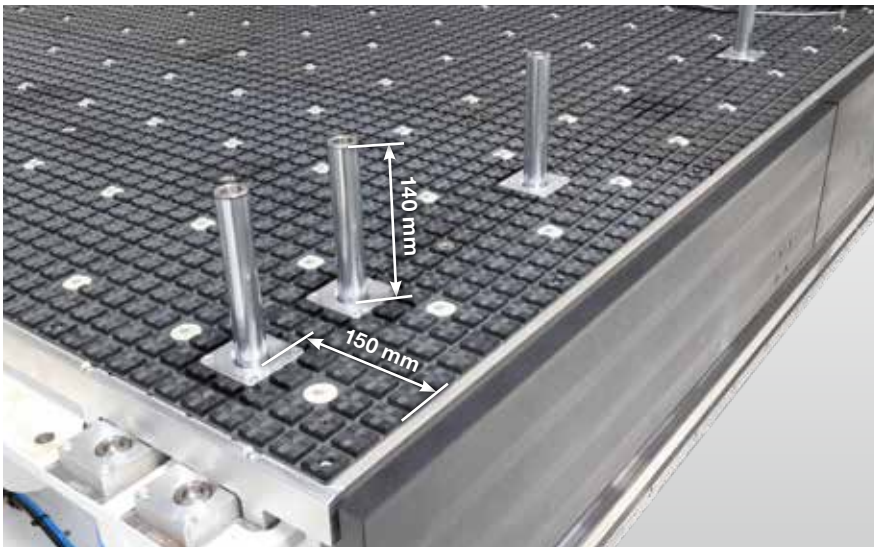

Stop cylinder

- Pneumatically lowerable aluminum stop cylinder
- The stop cylinders are installed in such a way that the suction cups can be placed as close as possible to the cylinder without any vacuum loss.
- It is possible to place additional stops in the table

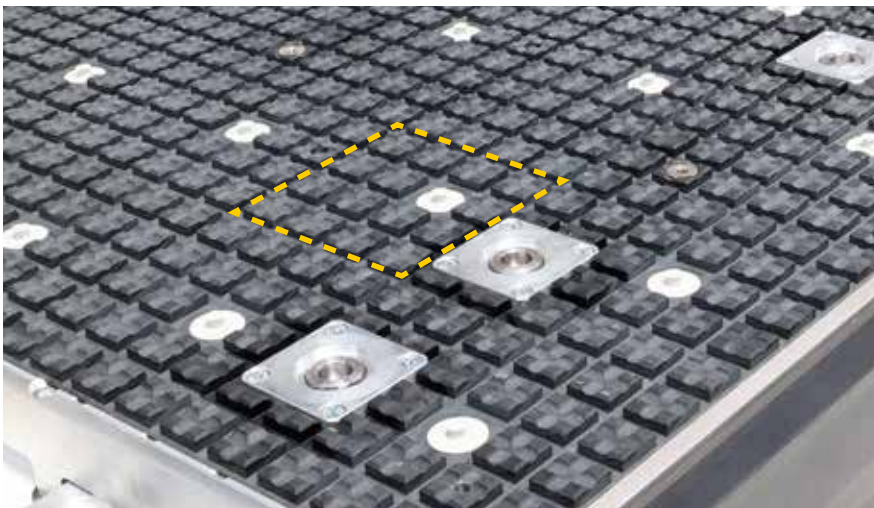

Positioning of clamping devices

- The optimal connection points for the vacuum, as well as the positioning of the stop cylinders allow the maximum use of clamping devices at almost any position

Clamping elements

Various clamping elements are optionally available

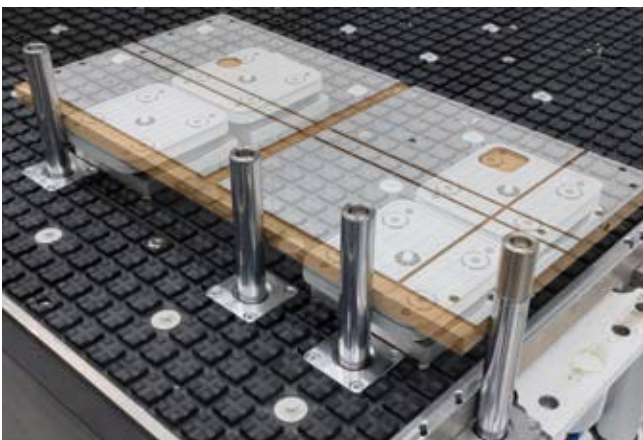
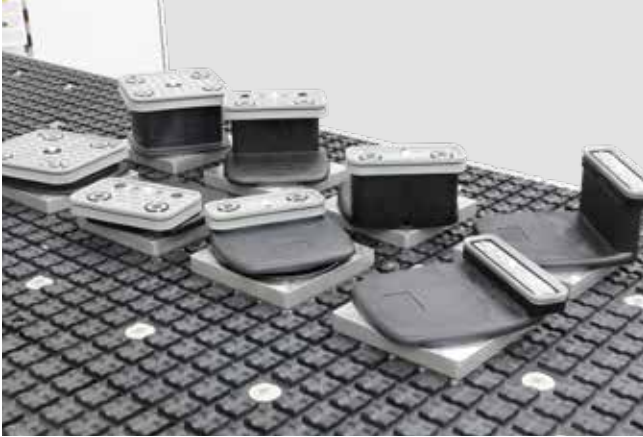

Notice: To fix suction cups to the protection plate, it is necessary to use a foil between the two elements.

Alternating operation

Gapless changeover between left and right table sides

Separate vacuum supply and ventilation of the table sides enables normal and dynamic alternating operation. The vacuum fields are assigned to the table sides and can be controlled individually. While workpieces are being routed on one side of the table, they can be loaded on the other side. Highly efficient, time and money saving production.

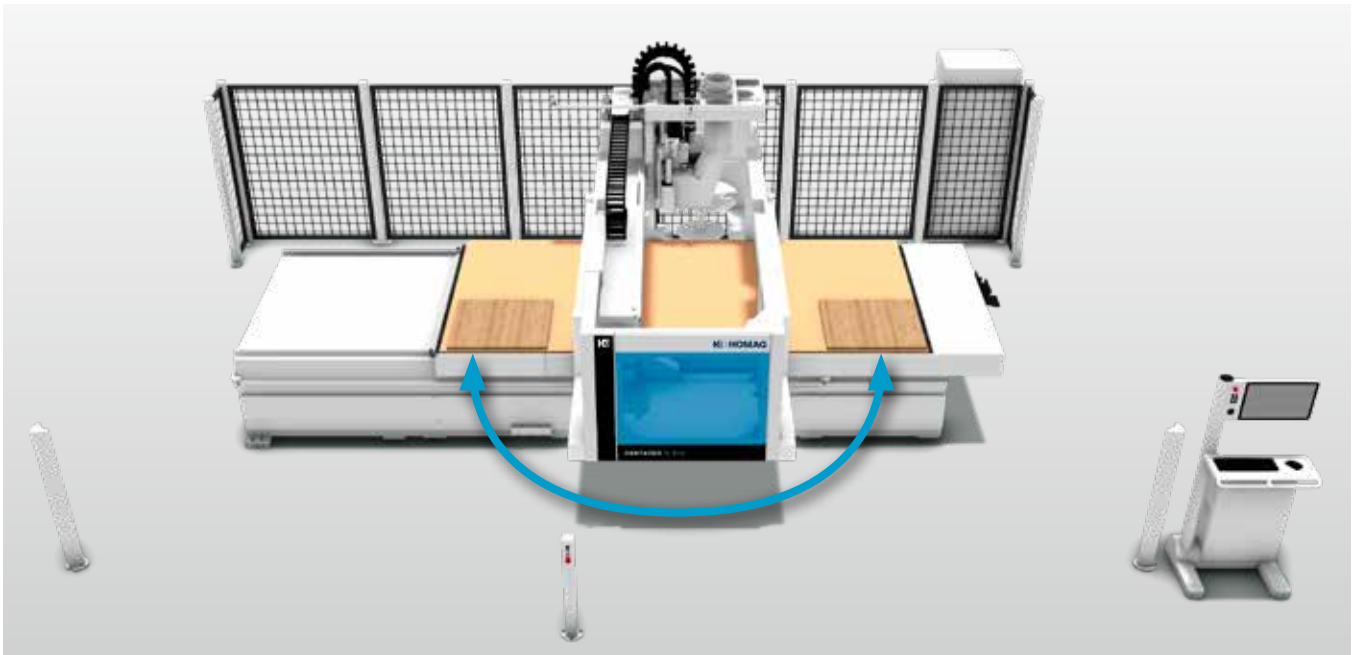

New: Dynamic pendulum loading in nesting as well

- Simultaneous workpiece handling and processing of different components

Vacuum pumps

- Low-noise, efficient and compact vacuum pumps with low-maintenance claw technology
- Number variable depending on application and table size
- Automatic activation/deactivation of additional vacuum pumps available as standard. Important for individual vacuum requirements.

Quality and innovation down to the last detail

Innovative solutions for every task. Superior technology from the start. Every customer benefits from HOMAG system competence. The sum of decades of experience in machine and plant engineering goes into our machining centers.

Identical system components, uniform control technology and ergonomic operation ensure more productivity. The latest technologies for the variable high-quality workpiece shapes.

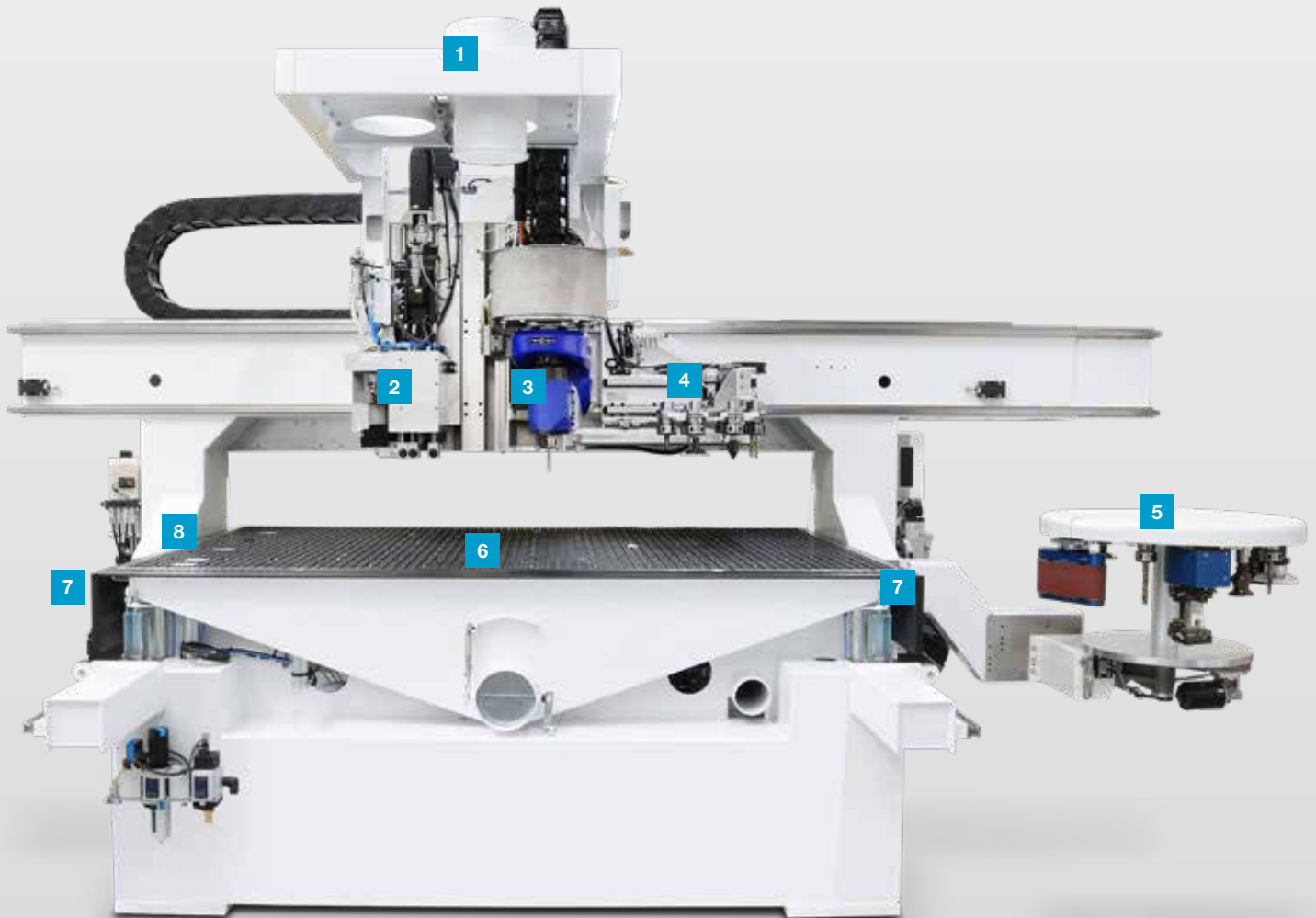

1 One central suction port for drilling unit, routing spindle, and protective panel/workpiece suction unit

3 Powerful 3-, 4- and 5-axis routing spindles

5 8- or 14-fold tool changing system moving in X-direction for high capacity and fast access

7 High-precision stop systems with linear guides and application-specific height control, double-sided synchronized drive system

2 High-speed drilling unit with patented spindle clamping and variable speed

4 8-fold tool changer moving along the spindle in X- and Y-direction for tool change while drilling

6 MATRIX table with flexible vacuum field division

8 Stop cylinder system integrated in the table for processing with an extensive clamping device portfolio

Main spindle technology

We are setting standards with our main spindle technology, increasing the performance and flexibility of our machines. Our highlights are the vibration sensors, which avoid damage to the routing spindles, and the 5-axis technology. Select the spindle suitable for your current and future product range.

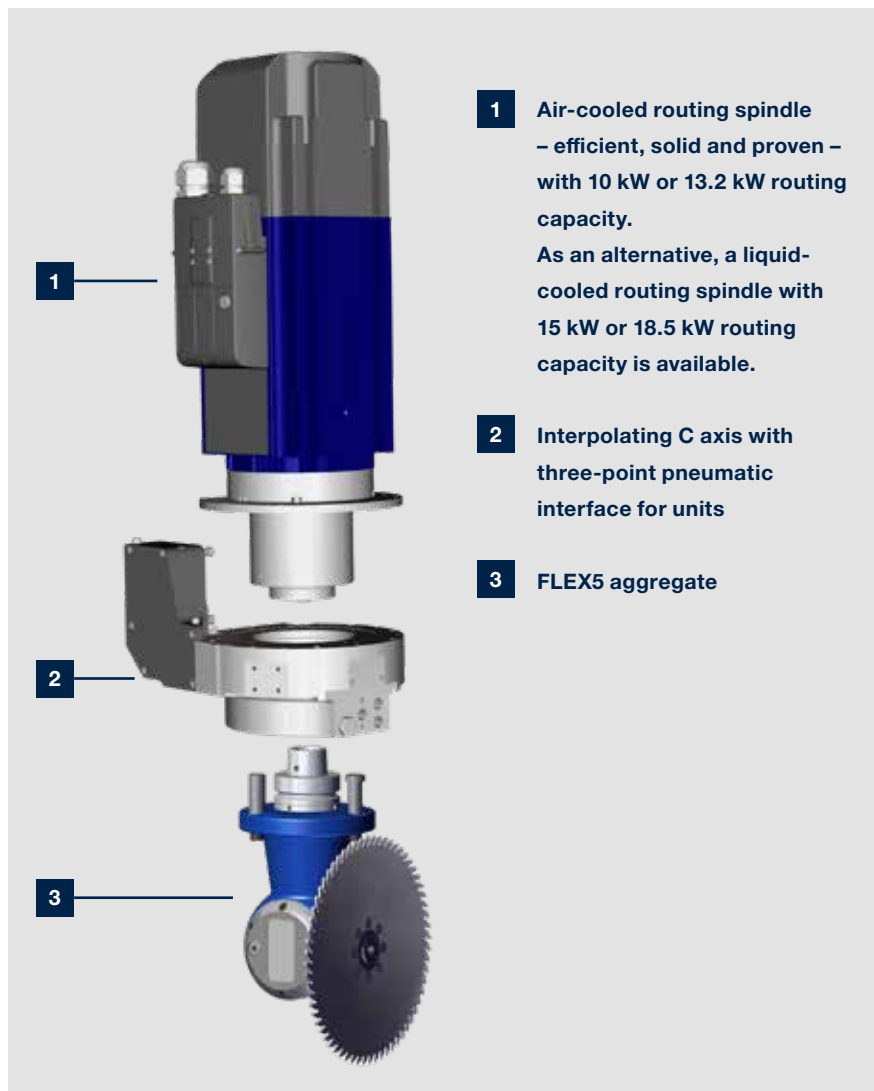

1 Air-cooled routing spindle – efficient, solid and proven – with 10 kW or 13.2 kW routing capacity. As an alternative, a liquid-cooled routing spindle with 15 kW or 18.5 kW routing capacity is available.

2 Interpolating C axis with three-point pneumatic interface for units

3 FLEX5 aggregate



Liquid cooling and spindle sensor (optional for DRIVE5CS) – liquid-cooled routing spindles with hybrid storage offer a long service life. An additional vibration sensor detects tool unbalances and protects the spindle against overloading, due to high feed speeds for example.



4-axis routing spindle with units interfaces, which open up almost unlimited production opportunities. With patented technologies the range of tasks can be expanded at any time.

Sawing, routing, drilling at any angle – FLEX5 aggregate with automatic angle adjustment. A unique unit for 4-axis spindles, which covers over 90% of 5-axis applications.



The smart DRIVE5CS 5-axis-head – compact design with short power transmission. Comprehensive technology on small space without limits regarding the processing range. Liquid-cooled spindle with 10 kW (as option 12 kW routing capacity) for efficient operations. The short design provides more space for processing (e.g. with a 350 mm saw blade, under the hood).

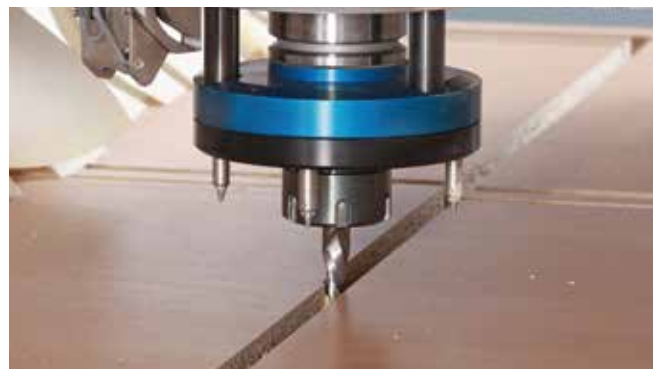

Pneumatic interface – the patented interface with 3-way support on all C-axes and optionally on the DRIVE5CS enables the use of traced units, e.g. for precise rounding off at the top and bottom no matter the thickness tolerances.

Units

Excellent processing quality and new standards for speed

The HOMAG units provide numerous innovative technologies. They can be combined and precisely coordinated to your specific application situation. Even special tasks are worked out safely and efficiently.



Corner notching unit



Underfloor routing unit



Drilling/routing unit



Drilling/routing unit



FLEX5 drilling/sawing/routing unit



Routing unit



Lock-case routing unit



Belt sanding unit



Eccentric sanding unit



[More information](#)
 you find on our website in the brochure
 »Unit and Clamping Element Catalogue«



HOMAG drilling technology

Patented, precise and durable

High-speed drilling technology and patented clamping of the spindle. Precise drilling, fast cycles, maintenance-free and durable construction.

Additional optional attachments expand the machine's range of applications.

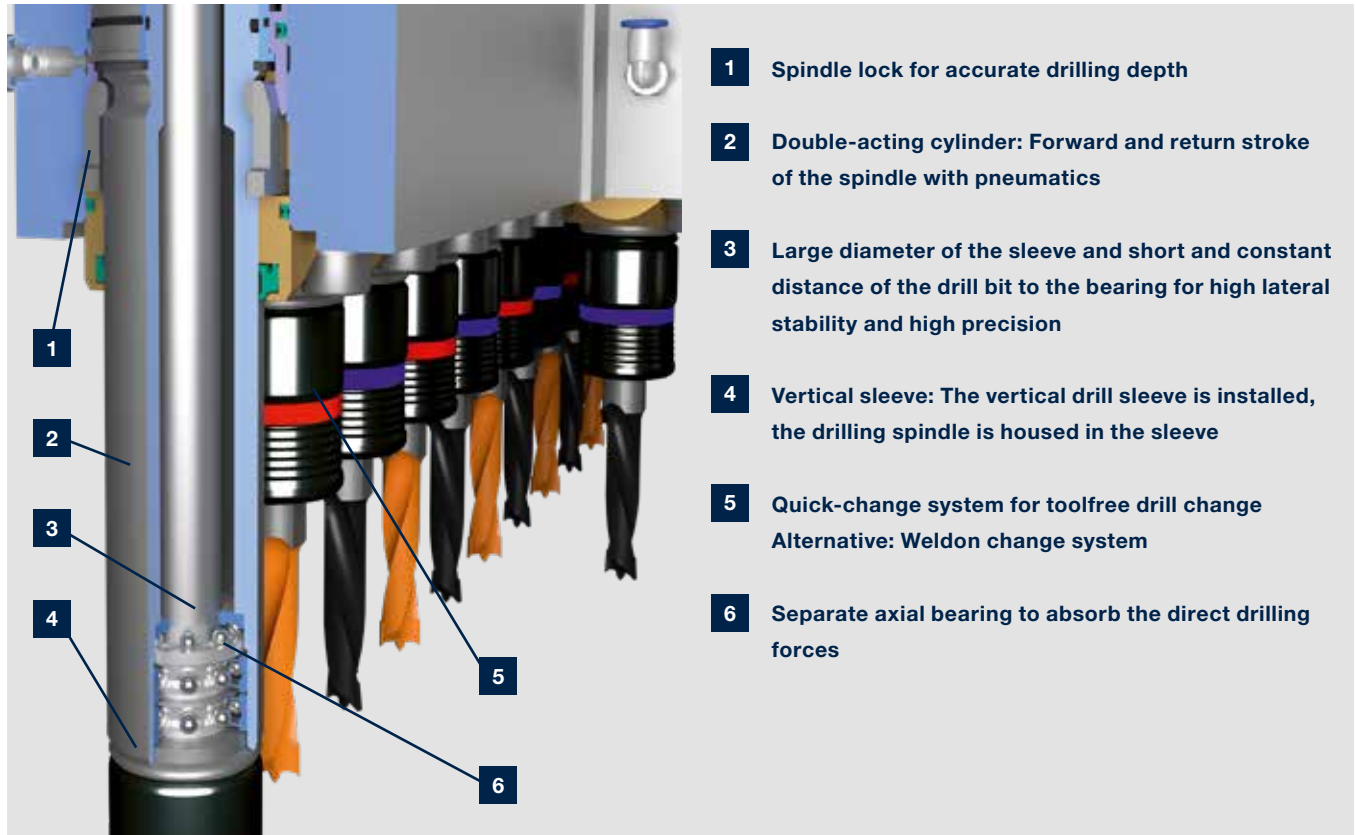

- 1 Spindle lock for accurate drilling depth**
- 2 Double-acting cylinder: Forward and return stroke of the spindle with pneumatics**
- 3 Large diameter of the sleeve and short and constant distance of the drill bit to the bearing for high lateral stability and high precision**
- 4 Vertical sleeve: The vertical drill sleeve is installed, the drilling spindle is housed in the sleeve**
- 5 Quick-change system for toolfree drill change
Alternative: Weldon change system**
- 6 Separate axial bearing to absorb the direct drilling forces**

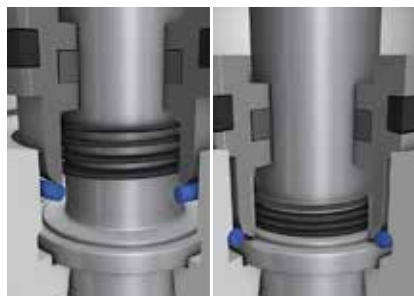

Automatic spindle lock — patented system for a drilling depth that is always accurate for numerous different materials. With speeds from 1500–7500 rpm for high feed speeds or short drill cycles.



Tool box »STARTER KIT«
Top equipment – from the very start



Weldon change system for a drill change with tools



Patented quick-change system for a drill change without tools to reduce setup times.

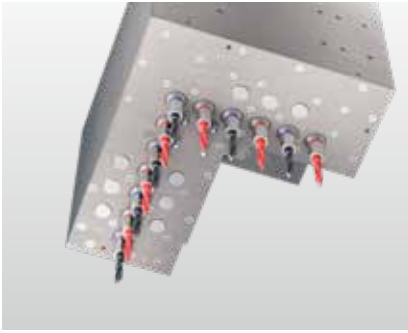

Drilling gear V12

- 12 drilling spindles [High-Speed 7500]
- 12 vertical drilling spindles

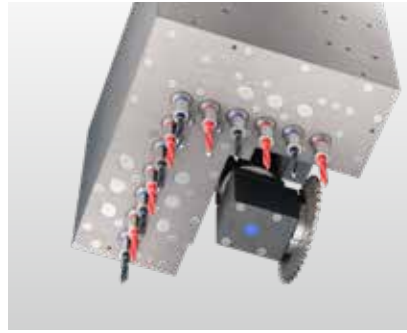

Drilling gear V12

- 12 drilling spindles [High-Speed 7500]
- 12 vertical drilling spindles
- Grooving saw Ø 125 mm (0° / 90°)

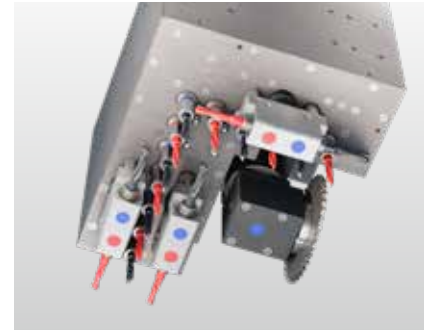

Drilling gear V12/H4X2Y

- 18 drilling spindles [High-Speed 7500]
- 12 vertical drilling spindles
- 4 horizontal drilling spindles in X
- 2 horizontal drilling spindles in Y
- Grooving saw Ø 125 mm (0° / 90°)

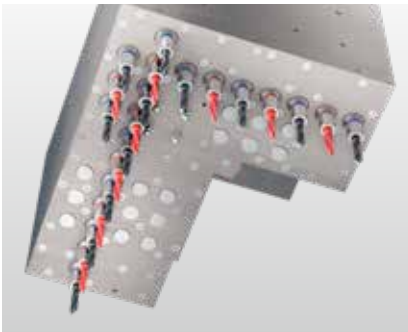

Drilling gear V21

- 21 drilling spindles [High-Speed 7500]
- 21 vertical drilling spindles

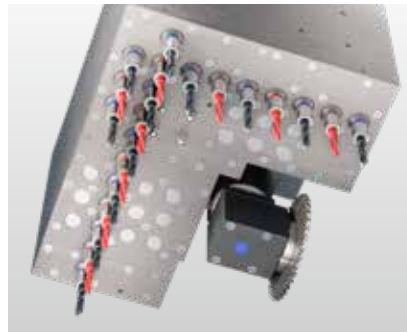

Drilling gear V21

- 21 drilling spindles [High-Speed 7500]
- 21 vertical drilling spindles
- Grooving saw Ø 125 mm (0° / 90°)

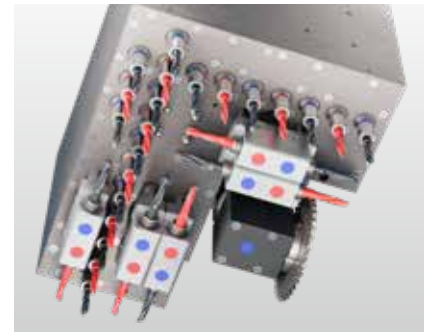

Drilling gear V21/H6X4Y

- 31 drilling spindles [High-Speed 7500]
- 21 vertical drilling spindles
- 6 horizontal drilling spindles in X
- 4 horizontal drilling spindles in Y
- Grooving saw Ø 125 mm (0° / 90°)

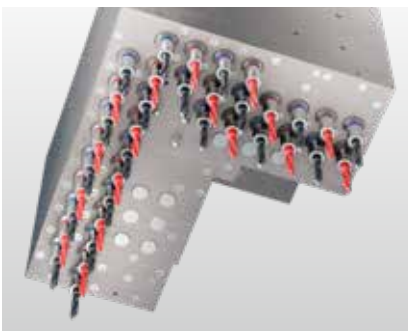

Drilling gear V36

- 36 drilling spindles [High-Speed 7500]
- 36 vertical drilling spindles

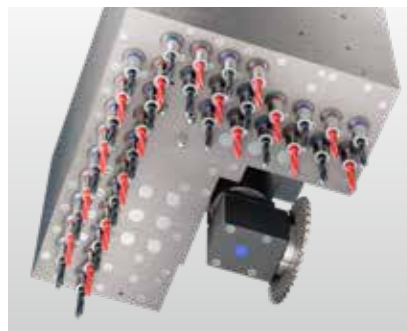

Drilling gear V36

- 36 drilling spindles [High-Speed 7500]
- 36 vertical drilling spindles
- Grooving saw Ø 125 mm (0° / 90°)

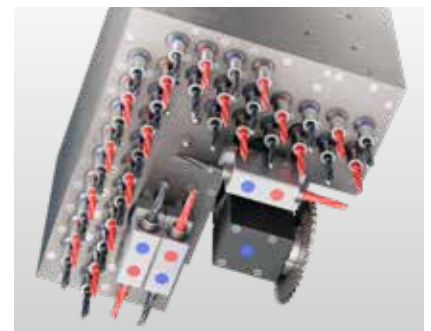

Drilling gear V36/H4X2Y

- 42 drilling spindles [High-Speed 7500]
- 36 vertical drilling spindles
- 4 horizontal drilling spindles in X
- 2 horizontal drilling spindles in Y
- Grooving saw Ø 125 mm (0° / 90°)

Tool changer systems

Simple flexibility

All neatly stored away for quick access. Tool changers provide the basis for the flexible deployment of tools and units, also for large saw blades or heavy processing tools. Right from the beginning you get up to 22 tool changing places.



Tool changing system

- 14-fold tool changer moving in X-direction

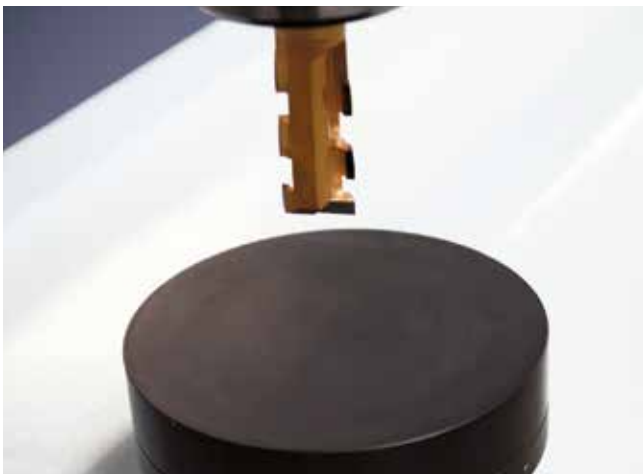

Tool length control

- After changing a tool, the length of the tool is queried and compared with the integrated tool databas



Tool pick-up station

- Folding transfer station at the front of the machine for efficient setup



Tool changing system

- 8-fold tool changer moving in X-direction

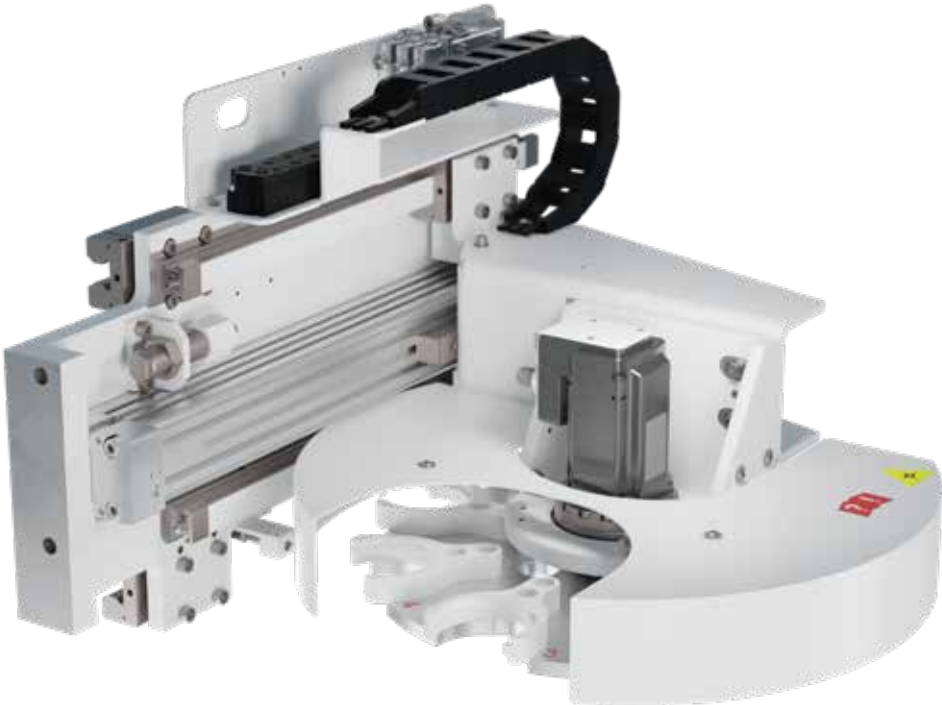

Tool changing system

- 8-fold tool changer moving in X- and Y-direction

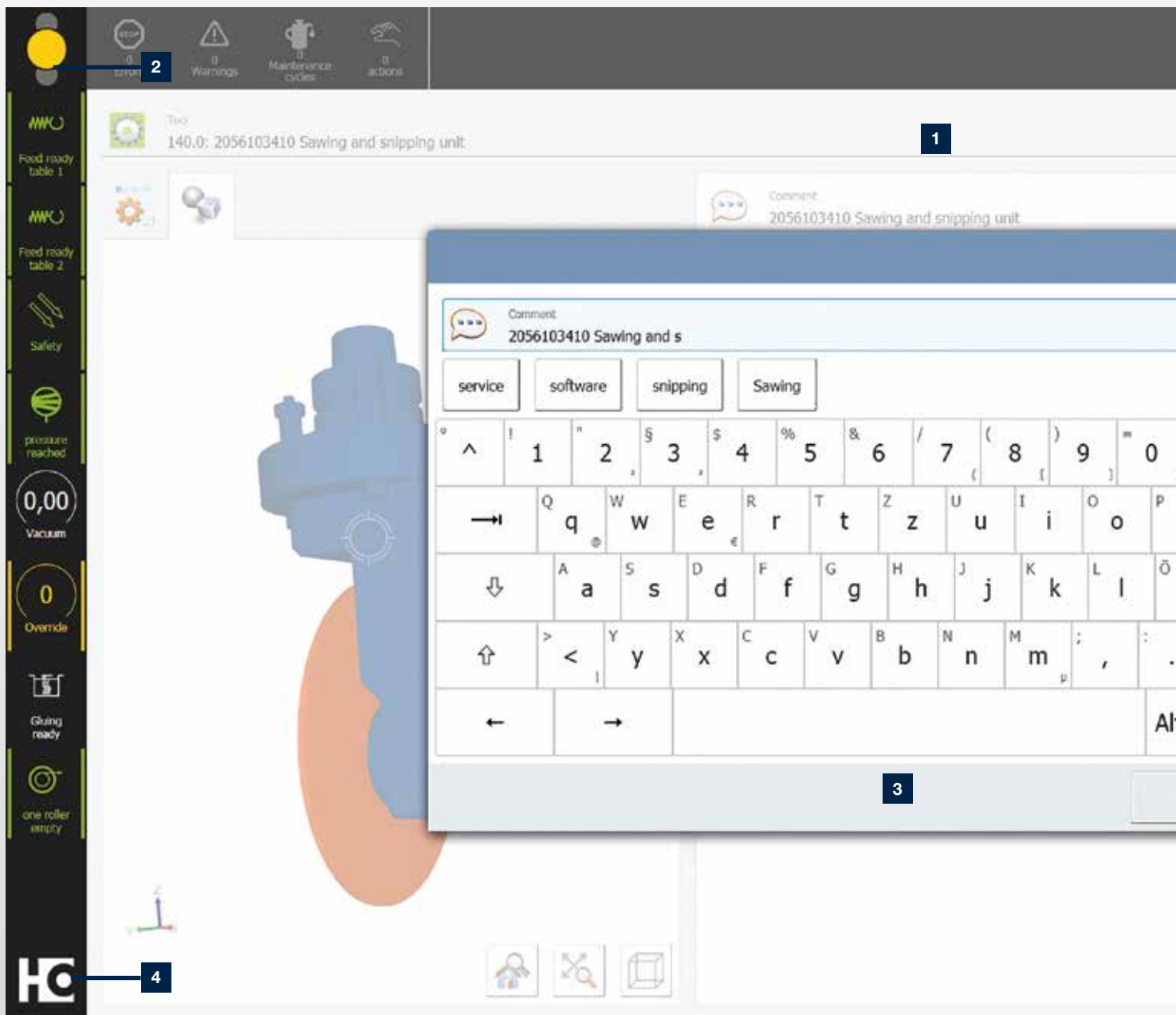

- 1 The powerTouch2 screen is clearly structured. You can see all the important information at a glance, but you still have all the details.
- 2 We have also improved the traffic light dialog further. You can now directly influence the machine's production readiness by selecting actions via the traffic light icon.
- 3 A functional pop-up keyboard that can be kept open, including automatic word completion for faster entries (when you enter the first letters, frequently used applications are proposed and you can select them directly).
- 4 Enhanced "Start" menu with additional information displayed (e.g. an indication of how many messages are currently pending or status bars that show the progress of the application) and direct access to actions (e.g. confirmation of actions without having to jump to the application).

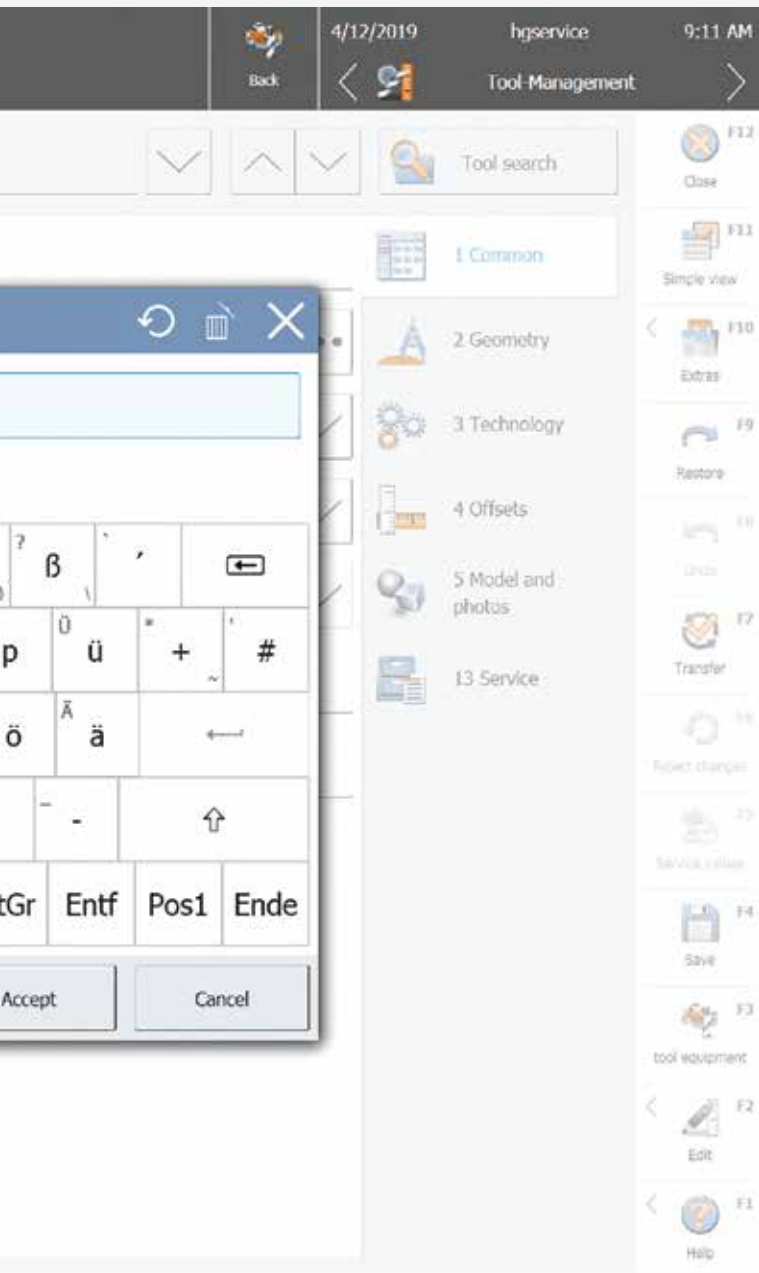

The next generation of powerTouch: **powerTouch2**

Faster, more comfortable, clearer: Enjoy the benefits of our further improved powerTouch user interface. We have optimized our standardized operating concept and further adapted it to our customers' requirements. Controlling your HOMAG machines is now even faster and more intuitive. The new, modern design has a clear structure. The innovative touch operation allows you to achieve the desired result easily and comfortably.

With the new powerTouch generation, you can enter information at your machine even more quickly. Compared to the previous version, you can achieve a time saving of up to 30%. This is possible thanks to new features, such as automatic word completion, a pop-up keyboard that can be kept open and Windows-like functions, such as the selection of common actions directly via the start button.

Our successful powerTouch philosophy – **standardized, simple, ergonomic, evolutionary** – consistently further developed

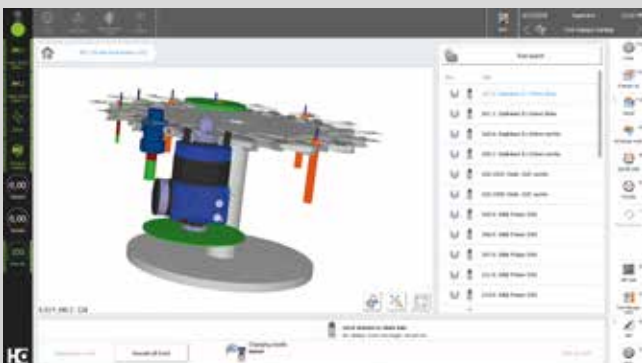

THE HIGHLIGHTS AT A GLANCE:

- Direct and efficient operation, up to 30% faster
- Clearer and more informative thanks to additional information and live illustrations instead of program icons
- New applications for operating and controlling machines and systems (e.g. NCCenter in the PC87 control system on CNC machines or woodCommander 4 on throughfeed machines)
- Fresh, attractive design, based on the new HOMAG machine design

Software | Machine

Our machines are equipped with everything needed for productive use as standard.

In addition, a wide range of software modules can be supplemented to create the optimum configuration.

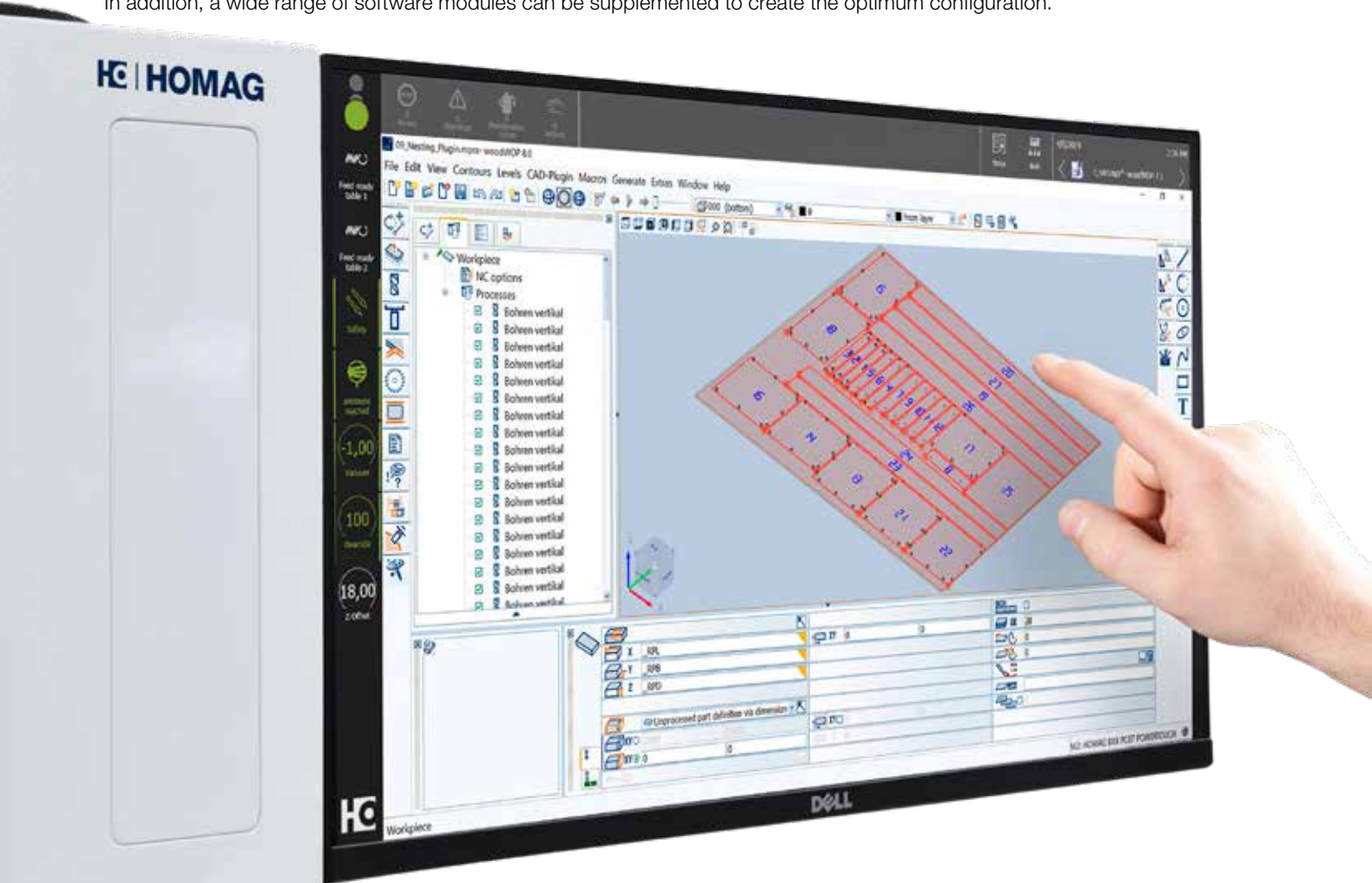

woodWOP

- The programming software for HOMAG CNC machines
- WOP programming, CAD design and CAM system combined in one software package
- High ease of use and more programming safety due to modern 3D user interface
- Variably expandable with many powerful additional modules

New in woodWOP 8.1

- **Additional parameters for macro names:** The display of important parameters in the macro tree creates a better overview of the existing edits in the woodWOP program.
- **Extensive revision of pocket macros:** New reference points, basic shape selectable, approach modes selectable.
- **Enhancements to block macro:** Multiplication via a position list, an uneven row or a circular row.



[Download](#)
woodWOP demo version

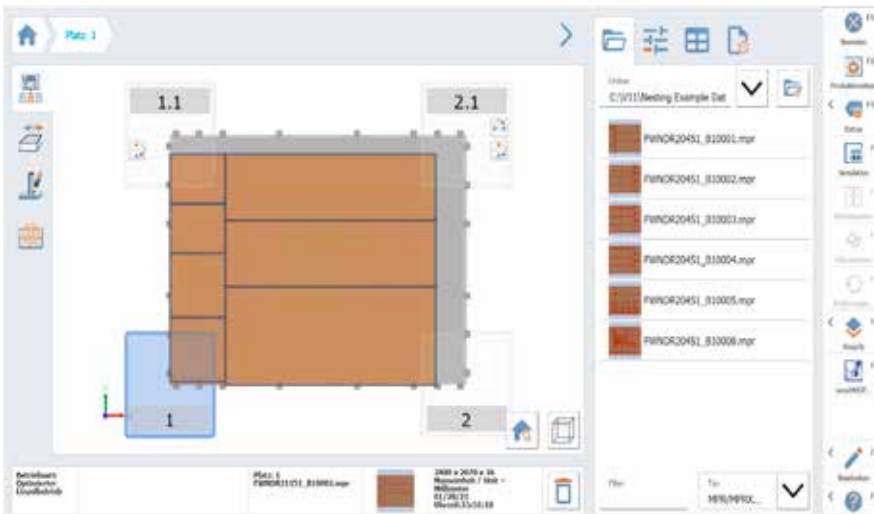

PC87 Slot assignment

- Simple control of main machine functions through soft keys
- Graphical loading

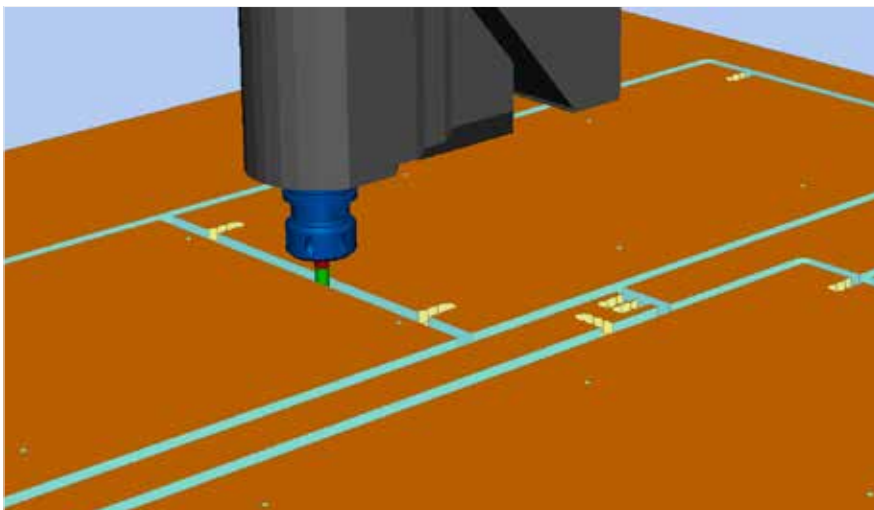

woodMotion

- Graphical 3D simulation software
- Material removal and residual part detection
- Collision detection
- Processing time calculation
- High realism through simulation based on a virtual machine control system

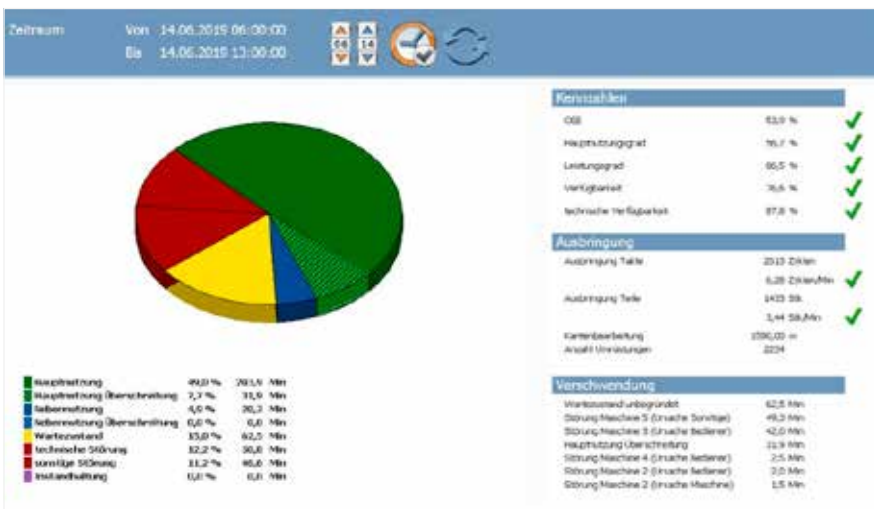

MMR Basic

- Machine Data Recording – collecting and evaluating machine states via time meter and event meter
- Display and logging of maintenance measures
- Expandable with further modules from the MMR product family



intelliDivide Nesting – Entry into cutting optimization for CNC machines

intelliDivide is the web-based cutting optimization program of the HOMAG Group. The optimization software enables, among other things, intelligent import from CSV, XLS(X), PNX, MPR, rectangular and free-form part optimization and part-in-part nesting. Part of the Nesting Production Set.

00001 P2_Weiss_19_2800_2070	
Material	P2_Weiss_19
Größe	2070,0x2800,0
Zyklen	1
Zyklusnummer	1

00001 MDF_Roh_19_2800_2070	
Material	MDF_Roh_19
Größe	2070,0x2800,0
Zyklen	1
Zyklusnummer	1

The advantages:

- No local hardware is needed. intelliDivide operates independently of the operating system; internet access is all that is required
- Users do not have to worry about maintenance or updates
- Low-cost entry into optimization
- Intuitive, simple operation.
- Simple, usage-based booking possible. Whether a free trial month, monthly subscription or annual subscription, every customer chooses the best option for them.

Cut Rite Nesting – Cutting optimization for CNC machines with many additional functions

Cut Rite is the HOMAG Group's cutting optimization for use in work preparation and can be used for saws and CNC nesting machines. Interfaces for data import and export are part of the standard scope. Other standard functions include batch mode, the definition of cutting rules and the assignment of priorities for parts.

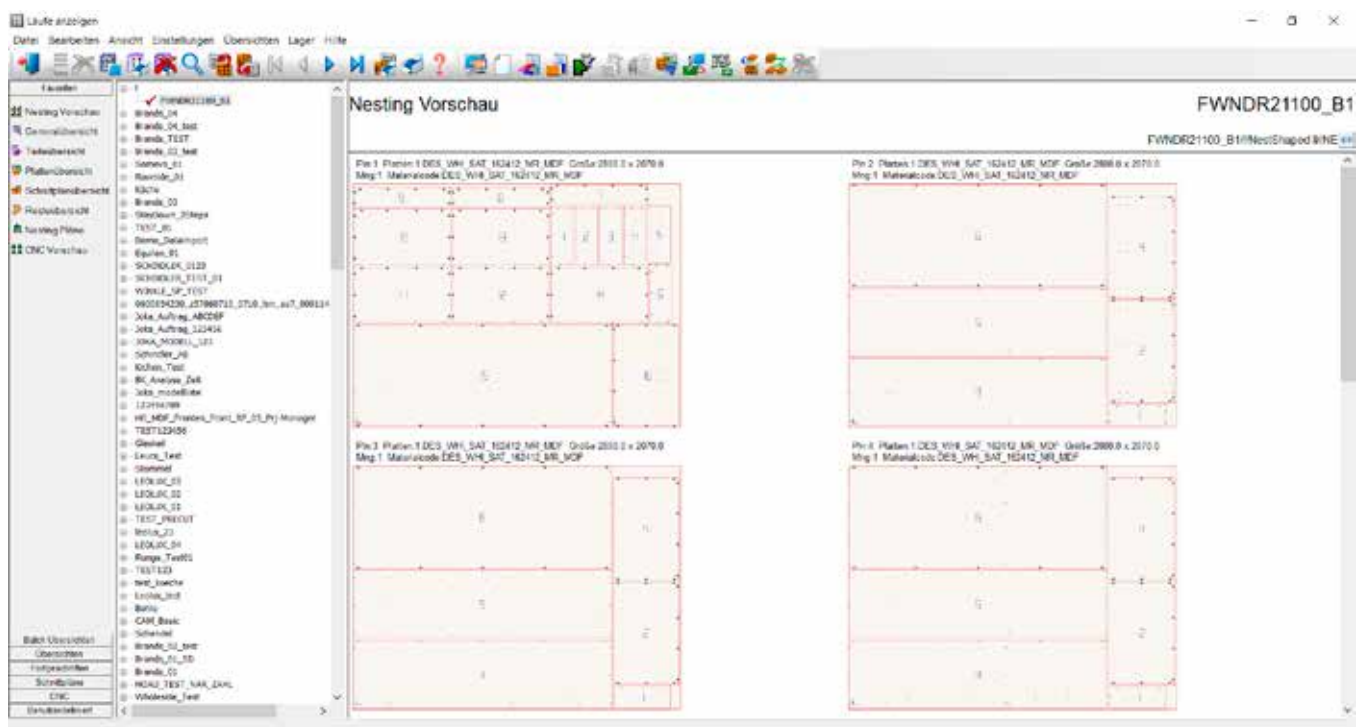

With the additional option Industry for Cut Rite Nesting, the waste can be further reduced (approx. 10 to 20% depending on the parts spectrum).

The woodStore interface is available for automatic communication with a HOMAG panel storage system.

The advantages:

- A software for cutting optimization for saws and/or CNC machines.
- High flexibility already included in the standard scope of delivery
- Seamless communication with the HOMAG automation concept and with the HOMAG panel storage system
- Wide range of options and interfaces for importing and exporting data

Apps and digital assistants.

Quick and easy support in your machine environment.

Some people still use pen and paper to create their cutting patterns. But they look at their smartphone if they want to know what the weather is like – instead of looking out of the window. We asked ourselves: why not combine the best of both? Our apps and digital solutions make your everyday work easier: machines, material, tools, cutting patterns, components – you always have everything in your pocket or on your desk.

EXCERPTS FROM YOUR FEEDBACK:

- Are there simple solutions that can eliminate various obstacles in my day-to-day work (e.g. when organizing materials or sorting parts)?
- Is there a way to slowly approach using digital assistants?
- Which tools can you try out simply and easily without having to invest huge sums of money straight away?

OUR ANSWER? SMART AND POWERFUL SOLUTIONS:

- ✓ Always low investment
- ✓ Always up to date (no updates necessary)
- ✓ Always easy to use (no complex software)
- ✓ Always helpful

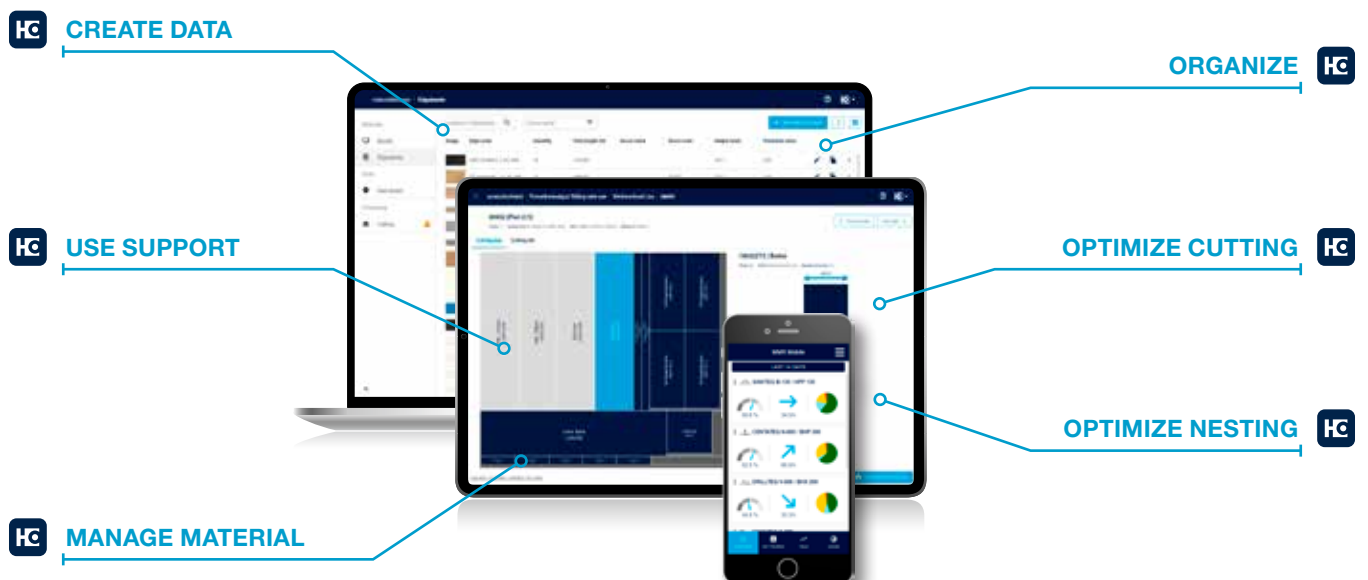



THE ADVANTAGES AT A GLANCE

- No investment, update or maintenance costs
Low starting price, no unplanned financial expense
- Licenses are independent of the user
Any number of employees can use the application without incurring additional costs
- Independent of hardware and operating system
Can be used anywhere, anytime
- Open system – import possible from almost all systems (ERP, industry software, CAD/CAM, Excel, CSV)
No obligation to use specific software systems
- Simple, smart operation
Minimal training required
- More efficient production
Jobs completed more quickly, more safely and in higher quality



More information at digital.homag.com

Safety concept Stripe bumper

The focus of the selected safety concept is on the interaction between machine and machine operator in individual operation.

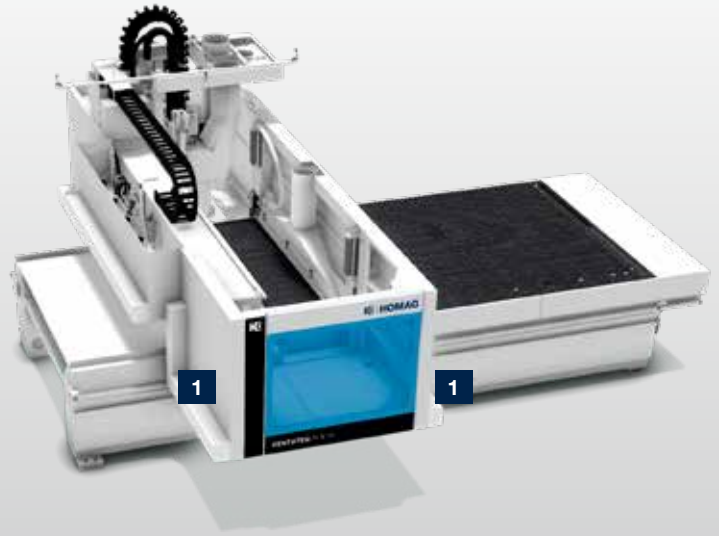

Safety concept Light barrier

The focus of the selected safety concept is on output and productivity. The system can produce independently, quickly and with high dynamic parameters without intervention.

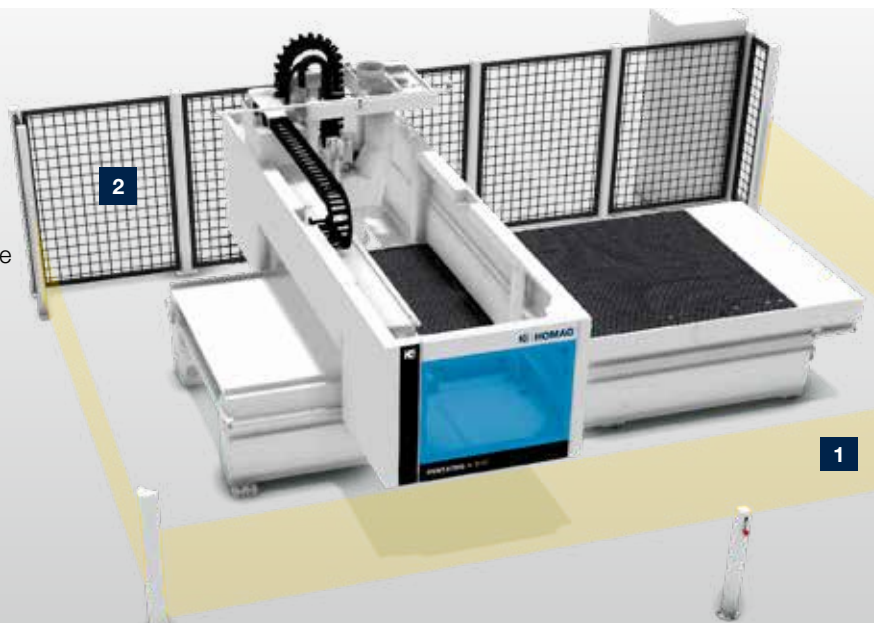

Safety concept Light barrier and stripe bumper

The focus of the two-stage safety concept is on the interaction and interplay between the machine and the machine operator. The system can also produce independently, quickly and with high dynamic parameters without intervention.

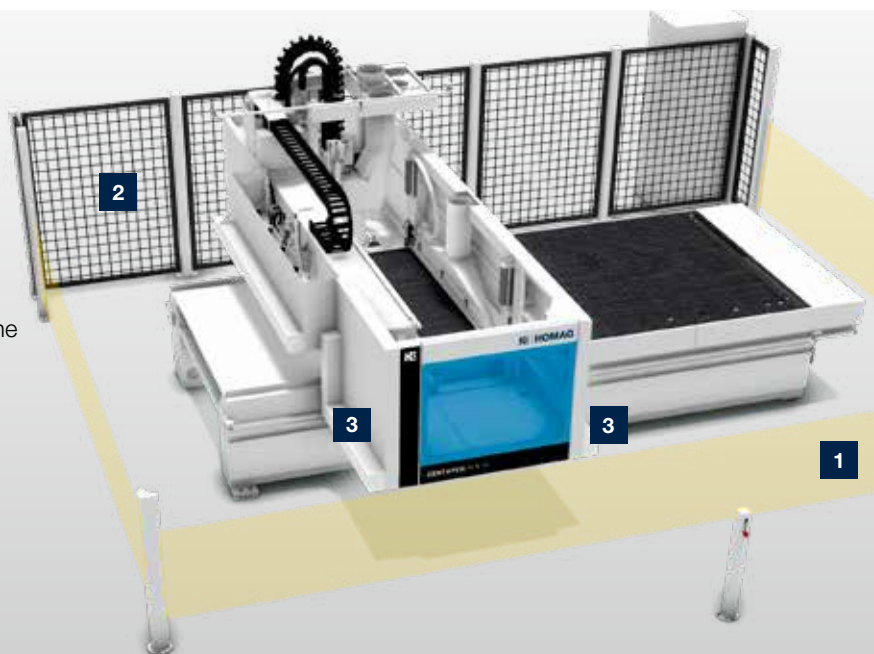

- 1 Stripe bumper:**
 - Travel speed with 25 m/min
 - Pendulum functionality possible

Highlights:

- Space-saving solution – stand alone machine



- 1 Light barrier:**
 - 3-beam light grid for barrier-free access from 3 sides
 - Modular expansion to automation possibilities

- 2 Protective fence:**
 - The protective fence secures the area behind the machine
 - Access to the rear working areas is possible through the left and right side of the machine

Highlights:

- Travel speeds of up to 100 m/min in X-direction



- 1 Light barrier:**
 - 3-beam light grid for barrier-free access from 3 sides
 - Modular expansion to automation possibilities

- 2 Protective fence:**
 - The protective fence secures the area behind the machine
 - Access to the rear working areas is possible through the left and right side of the machine

- 3 Stripe bumper:**
 - Reduction of travel speed to 25 m/min
 - Pendulum functionality possible
 - E.g. the lifting table can be loaded during processing

Highlights:

- Travel speeds of up to 100 m/min in X-direction
- When interacting with the machine operator, the traversing speed is reduced to 25 m/min in the X-direction





Robot integration

Automatic destacking with STACKBOT C-300

The smart concept allows parts to be picked from the entire nest as required and placed on a roller conveyor or stacked smartly onto a pallet. The workpieces can also be sorted into a transport carriage depending on the order.



Efficient robot cross rail

- Individual and automatic control of the individual suction cups
- Gentle workpiece handling thanks to rubberized suction unit surfaces
- Structures in the workpiece can be offset without reducing the suction power



Identification of the workpiece zero point

- Before picking, the barcode and the precise workpiece zero point are identified using a smart laser system, enabling precise stacking on a pallet.
- For chaotic stacking, the barcode must be applied according to a fixed pattern. Either centered on the workpiece, or in the area of the corners.



ADVANTAGES OF ROBOT INTEGRATION AT A GLANCE

- **High availability**
Machine running time can be extended to almost 100 %
- **Long lifetime**
No need to search for new workers
- **Highly flexible production**
No training of new processes necessary
- **Low maintenance operation**
24/7 availability (no vacation, sickness, breaks)
- **High cleanliness and low noise**
- **Ergonomics friendly**
Manual parts handling almost completely eliminated
- **Consistently high quality**
No reduction / change due to change of workers



Picking from the nest

- The robot has access to the entire nest
- The data for the workpieces is transmitted from the optimization plan to the robot

VALYOU

Our Mission, Your Performance.

LIFE CYCLE SERVICES

Improved performance, more efficient processes, faster help, assurance of availability and smarter workin

TEAM & COVERAGE

Largest global service network in the industry with over 1,350 personnel.

INSTALLATION & COMMISSIONING

For a smooth start, we only let proven experts manage your setup.

OPERATION & CONTROL

After teaching your personnel the intuitive control system, our clever apps help to make the operator's life much easier.

MAINTENANCE & SERVICING

To keep things running, we're happy to take a preventative approach. You decide how often and how intensively you want the support to be. As we all know, prevention is better than the cure.

eSHOP & ONLINE ADVANTAGE

A few clicks and it's fixed. Receive exclusive advantages by ordering spare parts online, depending on market availability. shop.homag.com

HOTLINE & READINESS

When there's an emergency, we're here. Direct by phone, digitally via app or video, or with on-site support. We are close to you with over 90 regional service organizations worldwide. With more than 35,000 spare parts immediately available, we can deliver 85% of your orders fast.

TRAINING & EDUCATION

With classroom, live online or eLearning training, we offer flexible options to help you get knowledge. We conduct over 4,000 customer training courses every year, and we even have our own training centers in 19 countries

MODERNIZATION & IMPROVEMENT

Our modernization program is tailored to your machines and processes. We can evaluate your data and situation and advise you on the next step.

ANALYSIS & SUSTAINABILITY

On request, we analyze all your processes with proven tools and procedures (LeanSixSigma). We have a large, certified team of experts for this purpose.

FINANCING & CONSULTING

We offer you tailor-made financing concepts worldwide. With more than 60 years of experience and a close partner network of prominent banks and insurance companies to help us to find the right solution for you, we're always transparent and reliable in processing.



Fast support:
94% resolution rate
via our hotline

Close to you:
1,350 service experts worldwide

We get things moving:
Over 1,000 worldwide spare parts
shipments each day

No one else has that:
Electronic documentation on over
150,000 machines, available in 28
languages

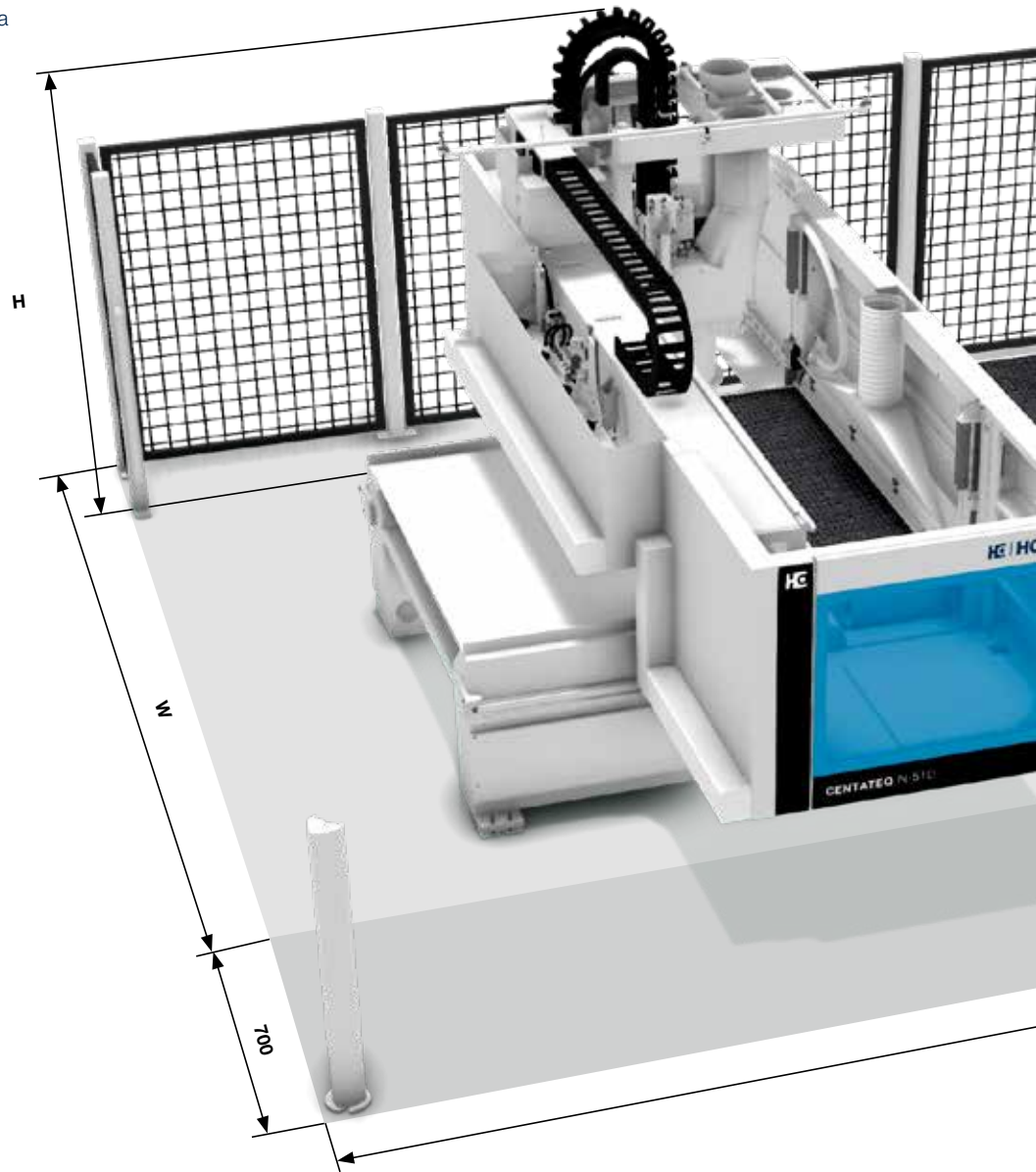

WORKING DIMENSIONS

Y = Workpiece width [mm/inch] 2 Z-axes	A = 0° with tool diameter 25 mm	A = 90° with tool length 195 mm / with all aggregates	Drilling / Loadable workpiece
/12	1.260 / 49,6	1.260 / 49,6	1.260 / 49,6
/16	1.590 / 62,6	1.590 / 62,6	1.590 / 62,6
/19	1.890 / 74,4	1.890 / 74,4	1.890 / 74,4
/22	2.160 / 85,0	2.160 / 85,0	2.160 / 85,0

X = Workpiece length [mm/inch]	A = 90° with tool length 195 mm / with all aggregates	
	Individual processing	Alternating processing
/25	2.550 / 100,4	–
/32	3.180 / 125,2	775 / 30,5
/38	3.810 / 150,0	1.100 / 43,3
/44	4.400 / 173,2	1.400 / 55,1
/57	5.700 / 224,4	2.050 / 80,7
/76	7.590 / 298,8	3.075 / 121,1

Z = Workpiece thickness [mm/inch]	from table	with clamping device H = 100 mm
	260 / 10,2	160 / 6,3

INSTALLATION DIMENSIONS

Machine type	Installation length [mm/inch]	Installation depth [mm/inch]	Installation height [mm/inch]
	L	W with 14-fold tool changer	H
/X/Y Compact	ca. X + 4.080 / X + 160,6	ca. Y + 3.890 / Y + 153,1	2.850 / 112,2
/32/22 Concept 2H+*	13.250 / 521,7	6.350 / 250,0	2.850 / 112,2

Technical data and photographs are not binding in every detail. We reserve the right to make changes during further development.



* For the position of the starter column, refer to the technical data sheet.

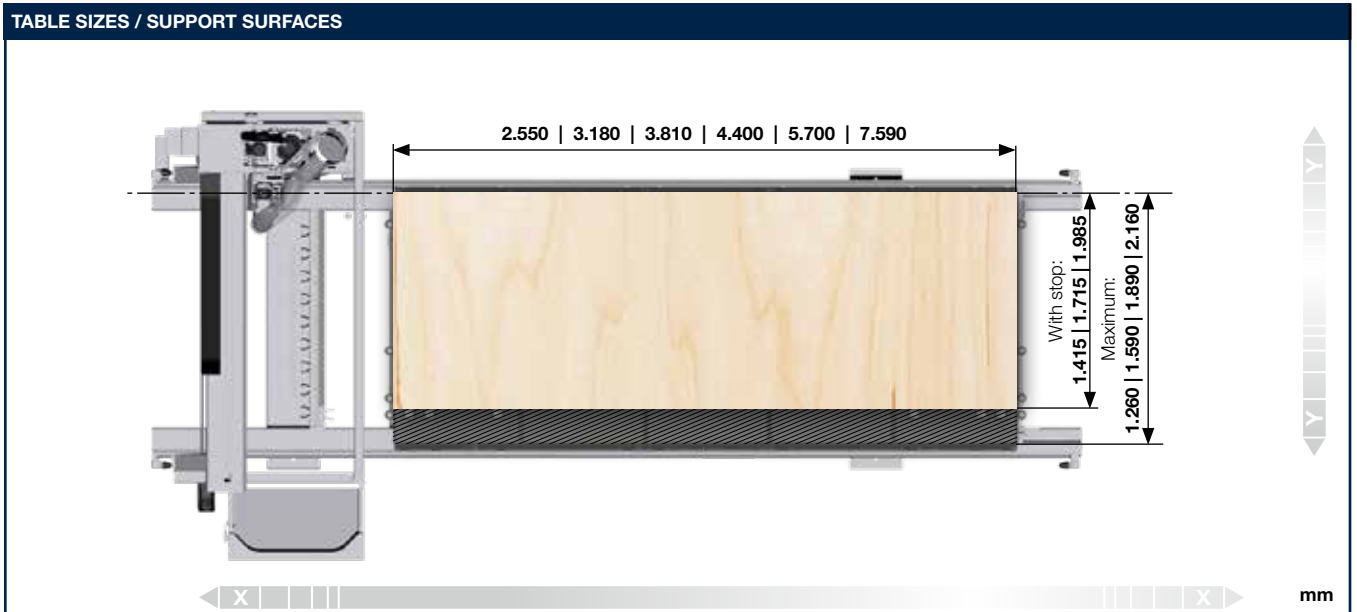
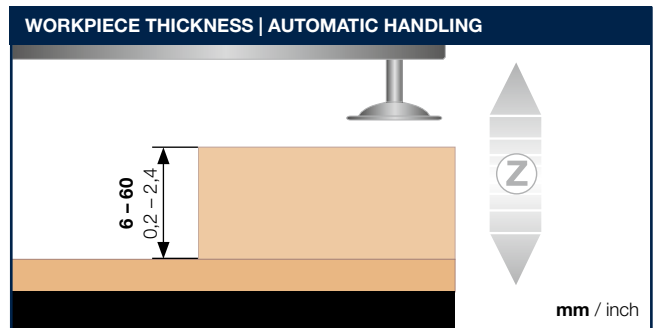



Status 05/23 | Technical changes, print errors and mistakes reserved. Pictures may show special equipment.



HOMAG Group AG
info@homag.com
www.homag.com

YOUR SOLUTION